

Fundamental Guide to

# Liquid Chromatography Mass Spectrometry (LCMS)

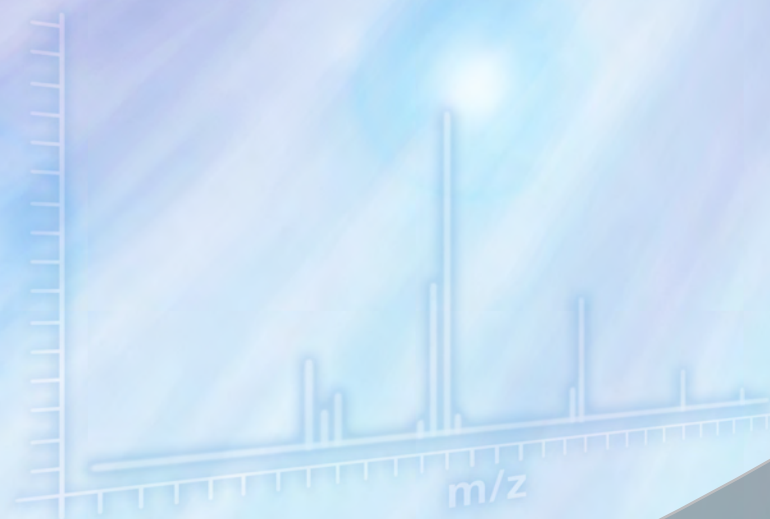



© Shimadzu Corporation

First Edition: October, 2018

Updated on: March, 2019

For Research Use Only. Not for use in diagnostic procedures.

This publication may contain references to products that are not available in your country. Please contact us to check the availability of these products in your country.

The content of this publication shall not be reproduced, altered or sold for any commercial purpose without the written approval of Shimadzu.

Company names, products/service names and logos used in this publication are trademarks and trade names of Shimadzu Corporation, its subsidiaries or its affiliates, whether or not they are used with trademark symbol "TM" or "®".

Third-party trademarks and trade names may be used in this publication to refer to either the entities or their products/services, whether or not they are used with trademark symbol "TM" or "®".

Shimadzu disclaims any proprietary interest in trademarks and trade names other than its own.

The information contained herein is provided to you "as is" without warranty of any kind including without limitation warranties as to its accuracy or completeness. Shimadzu does not assume any responsibility or liability for any damage, whether direct or indirect, relating to the use of this publication. This publication is based upon the information available to Shimadzu on or before the date of publication, and subject to change without notice.

Shimadzu Corporation focus on analytical and measuring instruments, medical systems, aircraft equipment and industrial machinery. Together with our partners around the world, we diligently strive to be a company that meets the challenges faced by society and develop products which contribute to the growth of industries and the enrichment of peoples' lives.



**1875** Genzo Shimadzu Sr. founds Shimadzu Corporation



**1987** **WORLD'S 1<sup>ST</sup> MALDI-MS LAMS-50K**

**1987**



LCMS-2010

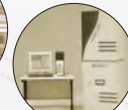

AXIMA-CFR



LCMS-2010A



AXIMA-QIT

**NOBEL PRIZE IN CHEMISTRY AWARDED TO KOICHI TANAKA**

**2002**

Koichi Tanaka Mass Spectrometry Research Laboratory established



**2003**



**World's 1<sup>st</sup> Ion trap TOF LCMS LCMS-IT-TOF**

**2004**



**World-Class General Purpose Prominence**  
LIQUID CHROMATOGRAPH

**LAUNCH OF UFMS TECHNOLOGY**

**2006**

**Prominence UFLCXR**  
Opening up new worlds and expanding possibilities through ultra-fast liquid chromatography

**2008**



**AXIMA** MALD-TOF MS models  
Acquire mass spectra directly from crude samples



**2010**

**Nexera X2**  
Delivers superior performance across a wider application range with flexibility and reliability

**UFMS**  
ULTRA FAST MASS SPECTROMETRY  
*Speed Beyond Comparison*

Shimadzu's revolutionary technology bringing next-generation analysis performance



LCMS-2020

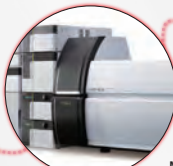

LCMS-8030

Minimized cross talk with UFsweeper™



LCMS-8040

Higher sensitivity with UF-Lens™  
Improved CID efficiency with UFsweeperII™



LCMS-8050

Achieved UFswitching™, UFscanning™ and UF-MRM™



LCMS-8060

Next-level quantitative detection with UF-Qarray™



LCMS-8045

Cutting-edge UFsweeperIII™, UF-grating™ and UF-FlightTube™ allows high-speed data acquisition for high-throughput analysis

**LCMS-9030**

Quadrupole Time-of-Flight Liquid Chromatography Mass Spectrometer



**2013**



**i-Series Nexera-i Prominence-i**

Integrated LC systems that provide high speed analysis, simplified method transfer, minimized environmental impact and easy maintenance

**iMScope TRIO**  
IMAGING MASS MICROSCOPE



Provides high resolution morphological imaging overlaid with molecular distribution images

**2014**

**2015**

**Nexera UC Unified Chromatography (UC) UHPLC/SFC Switching System**

World's 1<sup>st</sup> fully automated system that combines on-line SFE and SFC in a single flow path.

**2016**

**World's 1<sup>st</sup> Automated LCMS Module for Clinical Applications CLAM-2000**

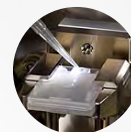

**DPiMS-2020**  
Quick and easy MS analysis without sample preparation

MALDI-8020



**2018**

**Nexera Mikros**

With the added UF-Link, this low flow LCMS system improves operability and enables high-sensitivity



# Foreword



Hirano Ichiro  
LCMS Product Manager

We are very happy to deliver you our first LCMS Primer which has very well compiled the basic principles and theory of mass spectrometry. It also describes the history of development of various innovative technologies to enhance the performance of our LC-MS/MS systems. It serves both as a textbook and a practical application guide, regardless of the scientific background and working field of the readers.

All market figures indicate that Shimadzu is the fastest-growing mass spectrometry company in the last decade. Since the product launch of our first triple quadrupole LC-MS/MS, LCMS-8030 in September 2010, we have been continuously rolling out the new LC-MS/MS systems to keep up to date with increasing needs. This year (2018), we are celebrating our landmarking launch of the LCMS-9030, our first ever Q-TOF instrument. Given these achievements, it is now our obligation and responsibility to deliver a primer to increase general understanding of the scientific foundation that we stand upon, while also pointing to the future of the LCMS that we are to realize.

I would like to express my gratitude for your eagerness to learn more about LCMS and taking time to read this primer. I sincerely hope that it satisfies your enthusiasm and gets you prepared for the new era of LCMS.

# List of Contents

<b>Chapter 1 Introduction to LCMS</b>	<b>4</b>
Fundamentals of LC, MS and LCMS	5
Comparison of LCMS and other techniques	9
Applications of LCMS	11
<b>Chapter 2 Integrating LC and MS</b>	<b>12</b>
Basic instrumentation of LCMS	13
Interfaces for LCMS	15
Electrospray Ionization (ESI)	16
Atmospheric Pressure Chemical Ionization (APCI)	18
Atmospheric Pressure Photoionization (APPI)	18
Overview of Atmospheric Pressure Ionization (API)	21
Mobile phases compatible for LCMS	24
<b>Chapter 3 Principles of MS</b>	<b>26</b>
Introduction to mass analyzers	27
Magnetic sector MS	28
Quadrupole MS	30
Time-of-Flight (TOF) MS	33
Ion Trap (IT) MS	37
Comparison of mass analyzers	39
<b>Chapter 4 Introduction to tandem MS systems</b>	<b>41</b>
Core principles	42
Types of MS/MS systems and their key characteristics	46
Triple Quadrupole (TQ) MS	47
Quadrupole Time-of-Flight (Q-TOF) MS	47
Multistage MS (MS <sup>n</sup> )	50
Ion Trap Time-of-Flight (IT-TOF) MS	50
Comparison of MS/MS systems	51
<b>Chapter 5 Challenges and development of LCMS</b>	<b>53</b>
Analytical challenges and current limitations of LCMS	54
Key developments in Shimadzu's LCMS	56
Ultra-Fast Mass Spectrometry (UFMS)	56
Clinical Laboratory Automation Module (CLAM)	58
Future trends of LCMS	59
Shimadzu's Comprehensive LC and MS Solutions	60

# Abbreviations

APCI	Atmospheric Pressure Chemical Ionization
API	Atmospheric Pressure Ionization
APPI	Atmospheric Pressure Photoionization
CID	Collision-induced Dissociation
CLAM	Clinical Laboratory Automation Module
DUIS	Dual Ion Source
EI	Electron Ionization
ESI	Electrospray Ionization
GC	Gas Chromatography
GCMS	Gas Chromatography Mass Spectrometry
HILIC	Hydrophilic Interaction Liquid Chromatography
HPLC	High-Performance Liquid Chromatography
ICP-MS	Inductively Coupled Plasma Mass Spectrometry
IEC	Ion Exchange Chromatography
IT	Ion Trap
IT-TOF	Ion Trap Time-of-Flight
LC	Liquid Chromatography
LCMS	Liquid Chromatography Mass Spectrometry
MALDI	Matrix-Assisted Laser Desorption/Ionization
MALDI-TOF	Matrix-Assisted Laser Desorption/Ionization Time-of-Flight
MRM	Multiple Reaction Monitoring
MS	Mass Spectrometry
MS/MS	Tandem Mass Spectrometry
MW	Molecular Weight
NPLC	Normal Phase Liquid Chromatography
PDA	Photodiode Array Detector
Q-IT	Quadrupole Ion Trap
Q-TOF	Quadrupole Time-of-Flight
RPLC	Reversed Phase Liquid Chromatography
RT	Retention Time
SEC	Size Exclusion Chromatography
SIM	Selected Ion Monitoring
SRM	Selected Reaction Monitoring
TIC	Total Ion Current
TOF	Time-of-Flight
TQ	Triple Quadrupole
UFMS	Ultra-Fast Mass Spectrometry
UHPLC	Ultra-High-Performance Liquid Chromatography
UV-VIS	Ultraviolet-Visible Spectroscopy

# Symbols

$\mu$	Micro
amu	Atomic mass unit
B	Magnetic flux density
E	Electric field
e	Elementary charge
g	Gram
k	Kilo
m	Mass
$m/z$	Mass-to-charge ratio
n	Nano
Pa	Pascal
V	Voltage
v	Velocity
z	Charge
$\omega$	Oscillation frequency

# Chapter 1

## Introduction to LCMS

The first chapter of Shimadzu's Fundamental Guide to LCMS introduces the basic principles of LC and MS. Common LC techniques, namely reversed-phase, normal phase and size exclusion chromatography, are described. Next, we introduced LCMS and compared it with other ionization and analytical techniques. Due to its superior sensitivity, high mass accuracy and robust performance, LCMS plays a key role and is widely used in many industries such as clinical, biopharmaceuticals, food safety and environmental.





## Fundamentals of LC, MS and LCMS

Liquid chromatography (LC) is a separation technique, first demonstrated in the early 1900s by Russian botanist, Mikhail Semyonovich Tswett. LC separates the components of a sample based on the differences in their affinity or retention strength for the stationary phase and mobile phase. This separation is illustrated in Figure 1 where the components in the sample are separated in a LC column.

There are different techniques of LC available and the principles of retention and

separation of each of the LC technique differs. Table 1 presents a list of the common LC techniques and their separation mechanism. With current advancements in LC, it has evolved into technologies of smaller particle sizes and higher pressure that are more efficient and of higher speed, sensitivity and resolution such as the high-performance liquid chromatography (HPLC) and the ultra-high-performance liquid chromatography (UHPLC).

### From HPLC to UHPLC: Extensive Lineup of Shimadzu LC

Shimadzu's extensive LC lineup fulfills a wide range of analytical needs, from conventional to ultra-high-speed analysis. With scalable column size and packing material particle size, Shimadzu can provide an LC system most appropriate for your applications.

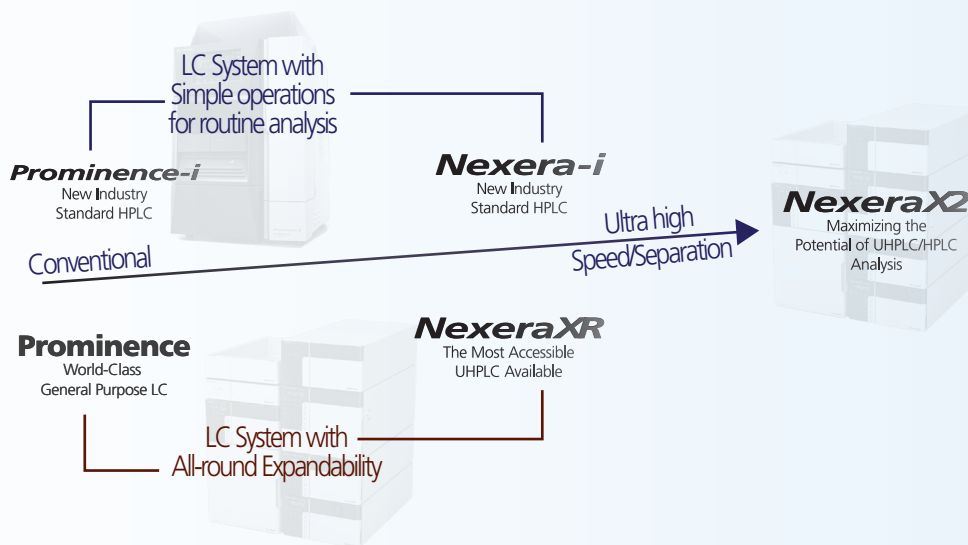

[CLICK HERE](#)

**Shimadzu's Shim-pack HPLC Column Guidebook**

A comprehensive column selection for your LC and LCMS analyses

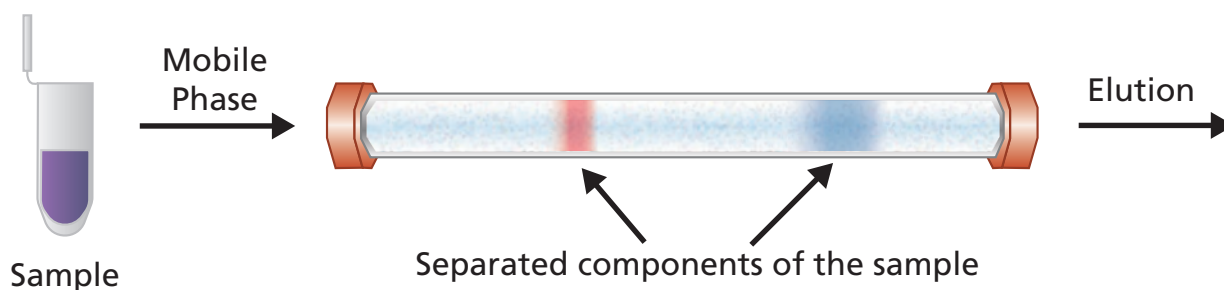

**Figure 1.** An illustration of how LC works. The sample (in purple) is injected into the LC column and gets separated into 2 analyte bands (red and blue) and gets eluted from the column.

**Table 1.** Different types of LC techniques and their separation mechanism.

Type of LC Techniques	Separation Mechanism	Commonly used for
Reversed-Phase LC (RPLC)	A non-polar stationary phase and a polar mobile phase is used for RPLC. Based on the 'like attracts like' principle, the sample is separated based on the molecule's polarity preference to either the polar mobile phase or the non-polar stationary phase. For example, the non-polar molecules will prefer to retain in the non-polar stationary phase rather than the polar mobile phase. As a result, it gets eluted later compared to the polar molecules.	Low molecular weight (MW) compounds
Normal Phase LC (NPLC)	NPLC works entirely opposite to RPLC. In NPLC, a polar stationary phase and a non-polar mobile phase is used. Polar molecules are strongly retained by the stationary phase as compared to the non-polar molecules. As a result, the non-polar molecules elute first.	Steroid hormones, phospholipids, saccharides and tocopherols
Hydrophilic Interaction Liquid Chromatography (HILIC)	HILIC works on the same principle as NPLC. The main difference is that water is added in the organic mobile phase to effectively separate and elute the strongly-retained polar molecules.	Polar compounds
Ion Exchange Chromatography (IEC)	IEC retains and separates charged species (ions) based on electrostatic affinity of the analyte for the stationary phase containing a functional group of an opposite charge. Differential elution is induced either by changing the pH of the mobile phase to neutralize the analyte, or by increasing the ionic strength (salt concentration) to competitively displace the analyte.	Proteins, amino acids, nucleotides, and inorganic ions
Size Exclusion Chromatography (SEC)	The SEC column used is filled with porous particles. When sample of various sizes flow into the column, smaller molecules migrate more slowly because they penetrate deep into the pores, whereas large molecules flow quickly as they do not enter the pores as much. As a result, larger molecules elute from the column sooner, which effectively sorts the samples by molecular size.	Proteins and synthetic high polymers

## Detectors for LC Systems

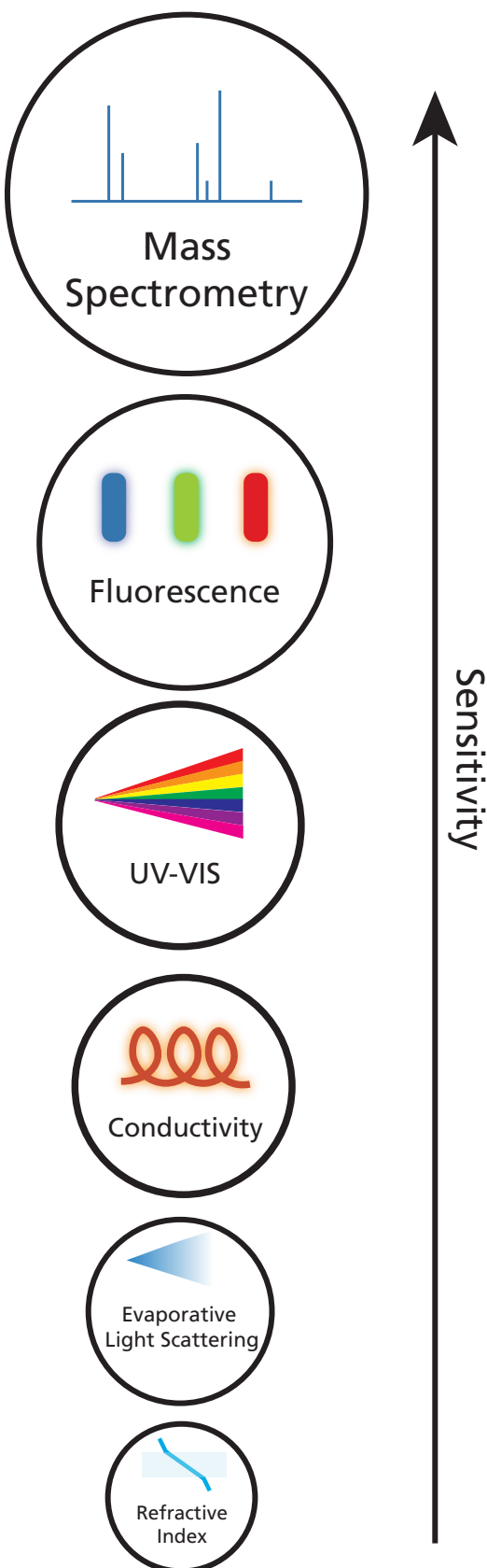

Figure 2. Various detectors for LC systems in increasing sensitivity.

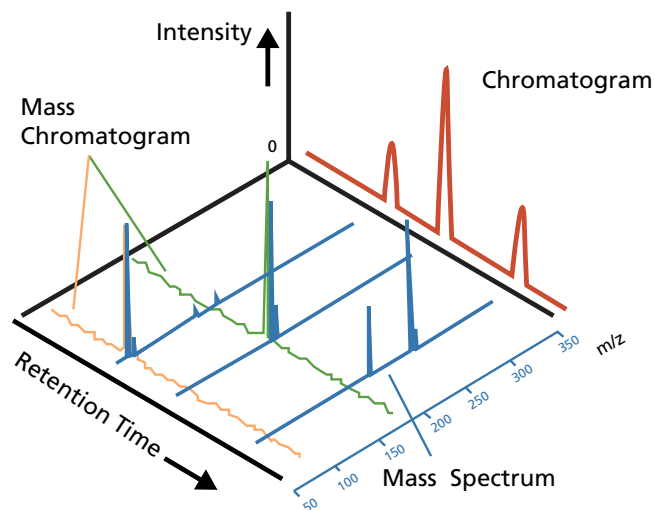

Figure 3. A typical LC chromatogram (red) and a LCMS mass chromatogram and mass spectrum (blue).

Upon separation by LC, the components can be detected using optical properties such as ultraviolet-visible (UV-VIS), fluorescence, refractive index, evaporative light scattering or electrical conductivity based on the analytes' properties. Figure 2 shows the various detectors for LC. When the analyte passed through the detector, a change (e.g. increase or decrease) in the optical property will be observed and recorded.

Chromatograms obtained using these optical detectors primarily identify or qualify substances based on the retention time and quantitate substances based on the peak area and intensity. The LC chromatogram (Figure 3, in red) shows an example of a typical chromatogram obtained using these optical detectors. LC coupled with optical detection offers great quantitative accuracy for analytes that can be chromatographically resolved, where a detected peak comprises only a single component. However, achieving required resolution is challenging for complex samples where multiple components elute approximately at the same time.



[CLICK HERE](#)

Ultra-high-speed analysis of preservatives in cosmetics using the high-resolution and the high-pressure tolerance of the Nexera UHPLC system.

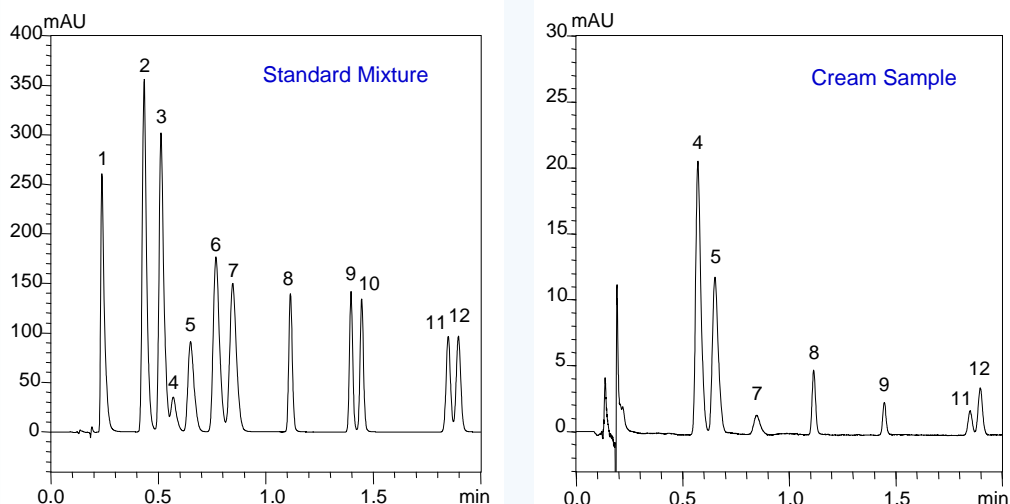

Chromatograms of parabens and preservatives in a standard mixture and cosmetic cream sample.

In contrast, mass spectrometry (MS) offers a highly sensitive detection technique that ionizes the sample components, separates the resulting ions in vacuum based on their mass-to-charge ratios ( $m/z$ ) and measures the intensity of each ion. A mass spectrum plots the relative ion intensities against the  $m/z$  values, and a series of mass spectra are generated at each time point (Figure 3, in blue). This information indicates the concentration level of ions that have a given mass and is extremely valuable for the unique identification of molecules, also known as qualitative analysis. Moreover, MS provides added specificity and sensitivity, and the convenience of simultaneous multi-component analysis.

With the coupling of LC with MS, the mass spectra obtained from these measurements provide molecular mass and structural information for eluted components, which supplement the qualitative information based on retention times obtained using other LC detectors. Therefore, LCMS combine the outstanding separation resolution of LC with the excellent qualitative capabilities of MS.

## Comparison of LCMS and other techniques

Apart from LCMS, there are various ionization techniques and analytical instruments for chemical analysis such as Inductively Coupled Plasma MS (ICP-MS), Matrix-Assisted Laser Desorption/Ionization (MALDI-MS) and electron ionization (EI) with gas chromatography MS (GCMS), MS was first introduced and used as a detector for GC systems in late 1960s and their advantages have been widely recognized.

GC separates volatile compounds in a column where the mobile phase is an inert gas and the stationary phase is either a packed column or a coated liquid. The compounds are retained and separated based on their polarity, volatility (boiling point) and their interaction with the stationary phase. After separation and elution from GC, the

compounds undergo a hard ionization (i.e. electron ionization (EI)) to form gaseous ions and are further analyzed by MS. Today, GCMS technologies provide a very effective means for separating, qualifying and quantitating substances, but its applicability is limited to gases or volatile compounds with relatively low molecular mass, and samples with high thermal stability (Figure 4).

LCMS was only made possible in mid-1970s with the introduction of atmospheric pressure ionization (API). With the use of API, the LC eluent vaporizes and ionizes to form gaseous ions, which are subsequently introduced into the MS. API is a type of soft ionization technique and examples include atmospheric pressure photoionization (APPI), atmospheric pressure chemical ionization

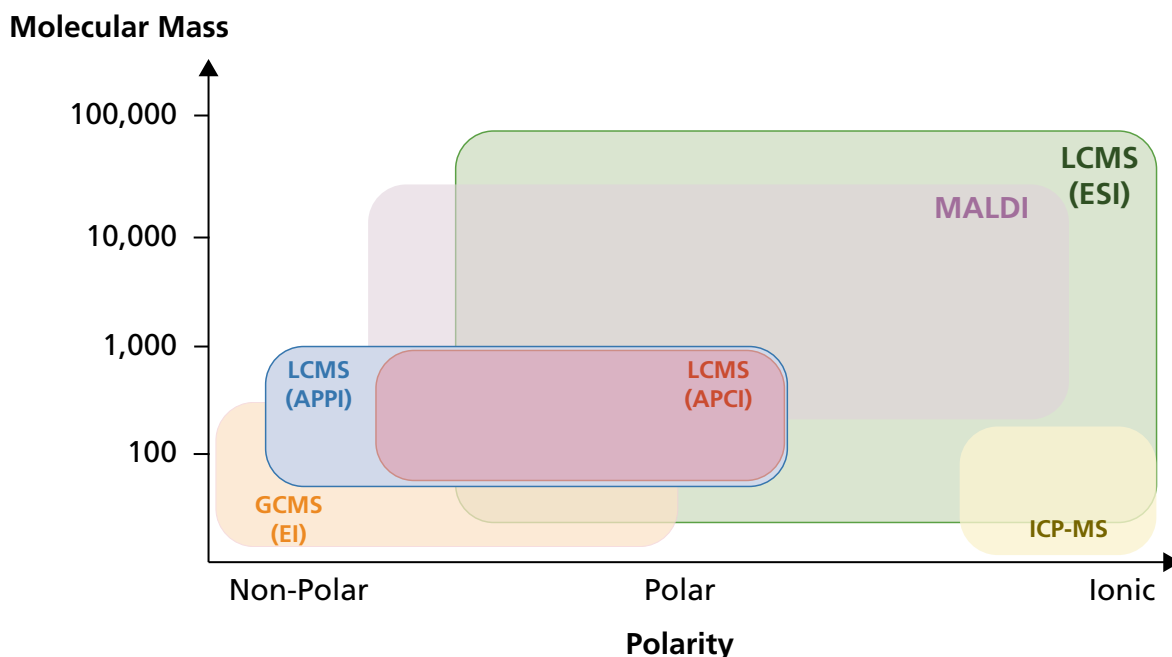



Figure 4. Common ionization techniques (APCI, APPI, EI, ESI, MALDI and ICP) and their range of applicability.

(APCI) and the commonly used electrospray ionization (ESI). These ionization techniques are discussed in greater detail in Chapter 2. Unlike GCMS, one of the advantages of LCMS is its broad applicability to a wide range of compounds (Figure 4). Once the sample is dissolved in a mobile phase, LCMS can analyze even the least volatile or thermally unstable compounds that are difficult to analyze using GCMS.

Other ionization techniques such as ICP and MALDI were later introduced in the mid-1980s. ICP-MS is frequently applied for elemental analysis while MALDI, a soft ionization technique, is commonly used for large molecules analysis (e.g. proteins, peptides and polymers). In summary, with the introduction of API techniques, LCMS provides broad applicability for an extensive range of substances (e.g. polar and non-polar) and offers high selectivity.



**CLICK HERE**

**Shimadzu Application Notebooks**

Refer to our compilation of application notes targeted for the various industries.



SHIMADZU  
Excellence in Science

Solutions for  
**Biopharmaceutical**

Application Notebook



SHIMADZU  
Excellence in Science

Solutions for  
**Environmental Analysis**

Application Notebook



SHIMADZU  
Excellence in Science

Solutions for  
**Food Development**

Application Notebook

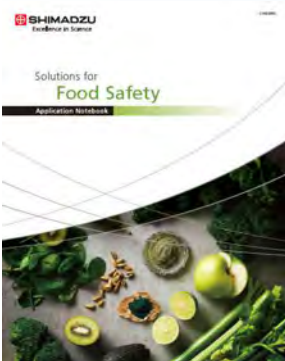

SHIMADZU  
Excellence in Science

Solutions for  
**Food Safety**

Application Notebook



SHIMADZU  
Excellence in Science

Solutions for  
**Pharmaceutical Analysis**

Application Notebook

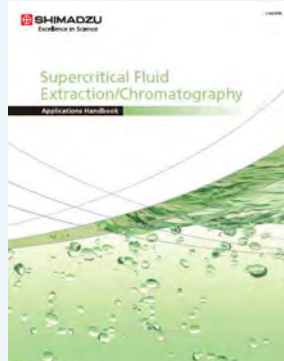

SHIMADZU  
Excellence in Science

**Supercritical Fluid  
Extraction/Chromatography**

Application Notebook

# Applications of LCMS

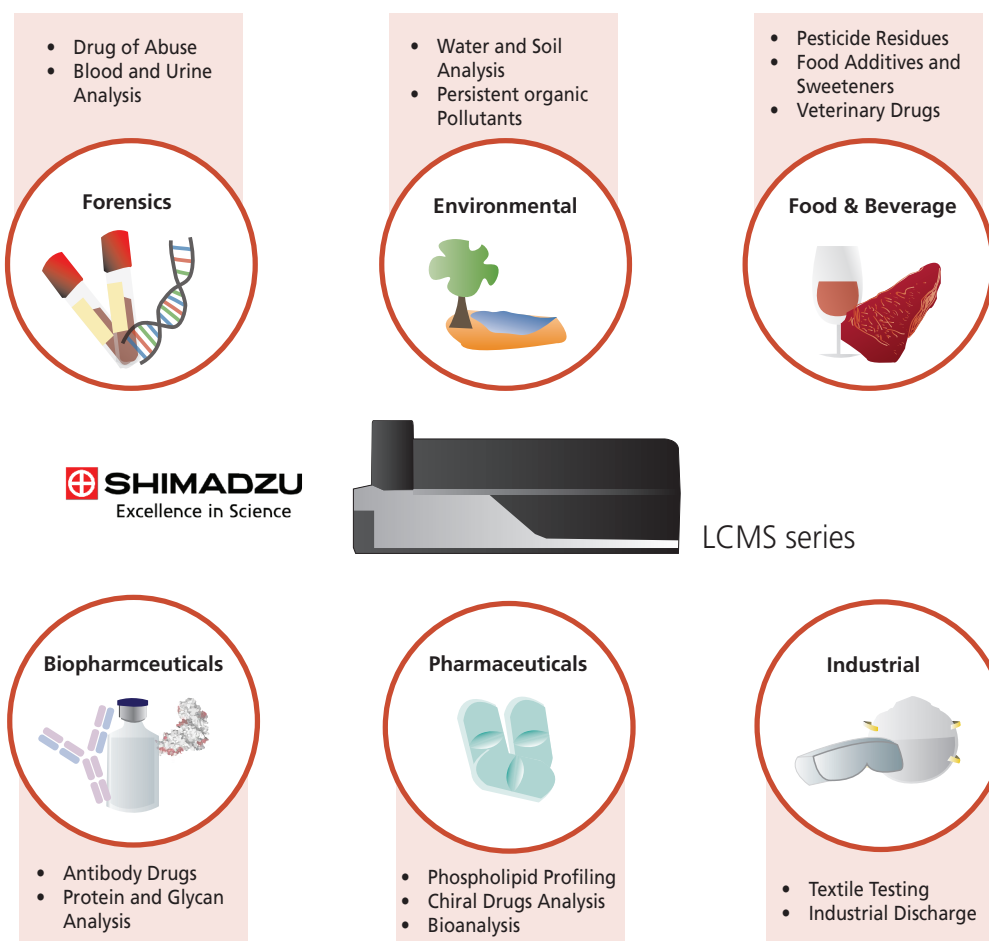

With its superior qualitative and quantitative capabilities and robustness, LCMS is commonly used to meet the rigorous demands of the analytical market and industries. LCMS is applied in many industries such as pharmaceuticals, biopharmaceuticals, forensic, industrial, food and environmental sector. For clinical research, the analysis of drugs, vitamins and minerals in whole blood, plasma, serum and urine is conducted routinely using LCMS. It is also applied in metabolomics, proteomics and genomics study. The use of LCMS in the biopharmaceutical discipline have enabled the bioanalysis and characterization of antibody drugs. In the environmental field,

LCMS is widely utilized for the qualitative and quantitative determination of known pollutants (e.g. pesticides, bacteria, pharmaceuticals and personal care products) and trace-level emerging contaminants. Food safety and development have also adopted the use of LCMS in their product quality control such as the quantitation of residual veterinary drugs, food additives and the composition analysis of supplements and organic foods. With high sensitivity, high detection selectivity and high qualitative capability, MS bring about the flexibility of simultaneous multi-component analysis, improved productivity and efficiency to HPLC analyses in these applications.

# Chapter 2

## Integrating LC and MS

Chapter 2 introduces the detailed configuration of the LCMS instrumentation. It generally consists of a LC separating system, a mass analyzer and the LCMS interface API unit. Generation of gaseous ions is crucial in LCMS and there are several factors limiting the efficiency of this API process. In addition, there are many analytical parameters to take note when switching from LC to LCMS, for instance, the flow rate and the types of mobile phases compatible with MS. In this chapter, we discussed in detail the API processes, their limiting factors and the key parameters to take note when coupling LC and MS.

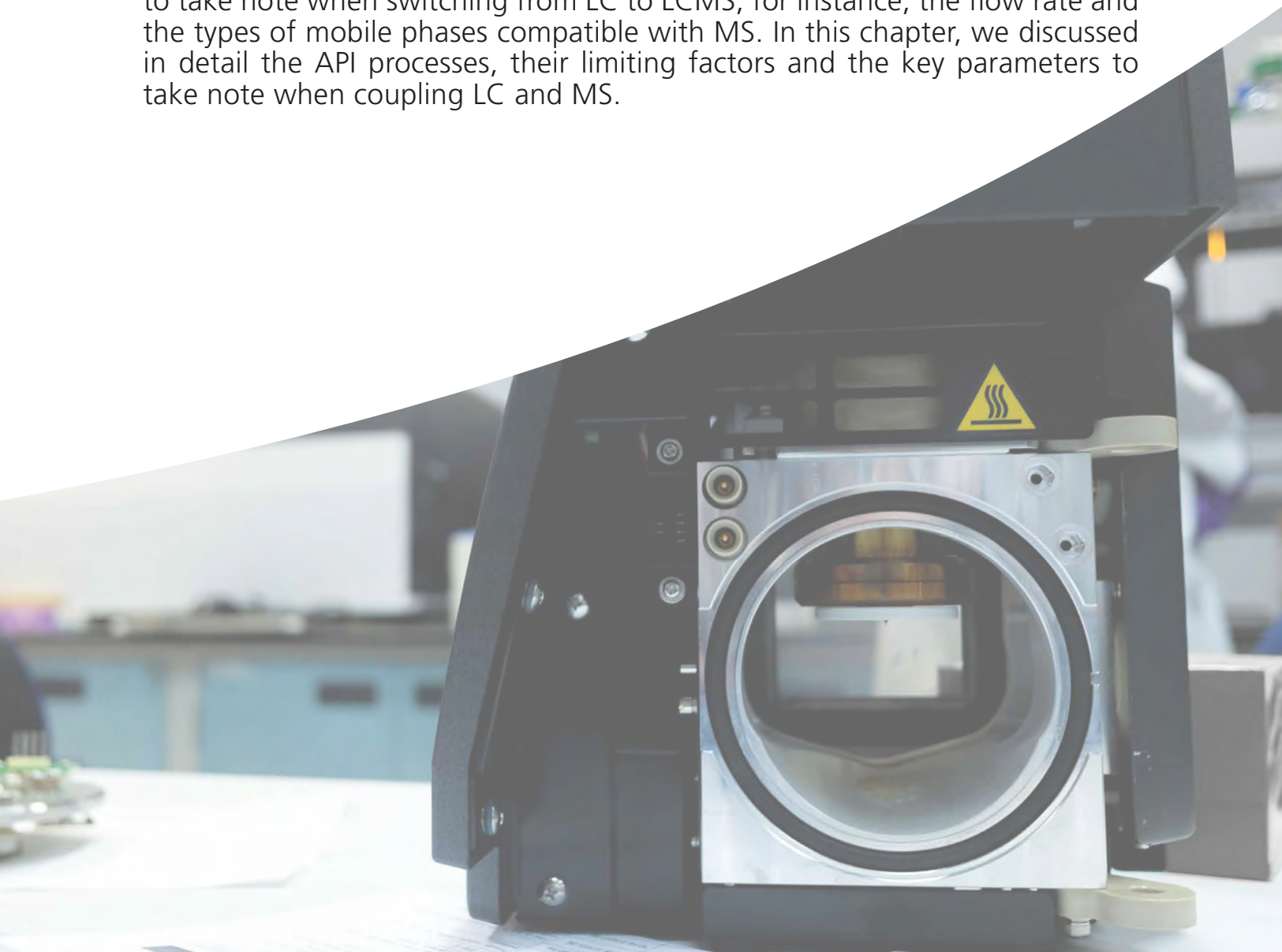



## Basic instrumentation of LCMS

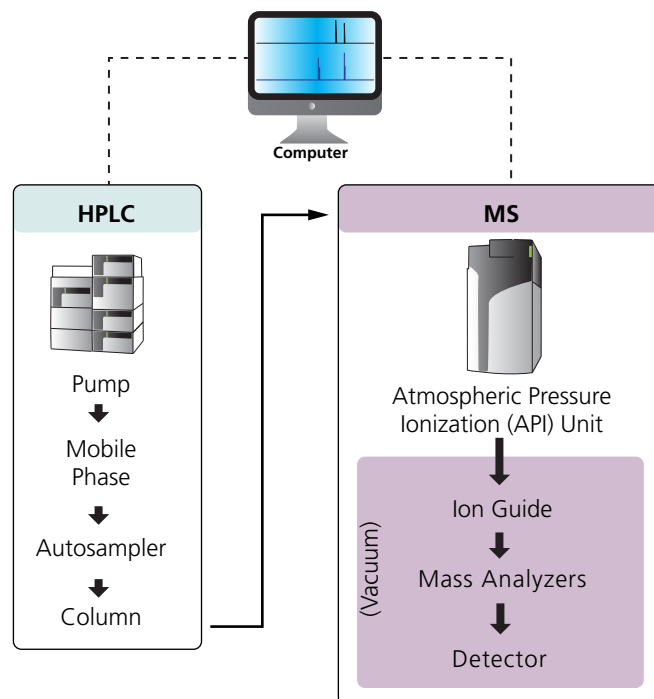

Figure 5. Basic components of a LCMS system.

**The basic components of a LC unit consist of:**

- (1) **Pump** – delivers the mobile phase at a required flow rate,
- (2) **Autosampler** – injects the samples,
- (3) **Column** – for separation of sample,
- (4) **Detector** – for the analysis of the separated components in a sample.

**For a LCMS system (Figure 5), the instrumentation comprises of:**

- (1) a **LC** unit,
- (2) an **interface** between the LC and MS,
- (3) an **ion source** that ionizes samples (e.g. API unit),
- (4) an **ion guide** (an electrostatic lens that efficiently introduces the generated ions into the MS),
- (5) a **mass analyzer** unit that separates the ions based on their mass-to-charge ( $m/z$ ),
- (6) a **detector** unit that detects the separated ions.

Examples of common MS detectors are electron multiplier and microchannel plate (MCP) where they operate by the secondary electron emission process. Together with the

LC chromatogram, the quantity of ions that reach the detector is converted to a signal intensity and output to a computer. The ion guide, mass analyzer and detector are all

housed in a vacuum in the MS. By holding it in a vacuum, the generated ions are able to be introduced, analyzed and detected in the MS with minimal collision and loss.

Besides the conventional LC which utilizes only one chromatography technique and column, there is the multi-dimensional chromatography which uses a combination of techniques (e.g. separation modes and/or columns) for separation. One such system is the two-dimensional LC (2D-LC) which can

achieve higher selectivity not possible with conventional LC alone. There are various setups (e.g. online and offline) for multi-dimensional LC and it can be coupled to a MS to give a 2D-LCMS. The use of 2D-LC in analyses can serve as a clean-up and pre-concentration step in a trap-and elute system. Another setup, a trap-free 2D-LC-MS/MS system, can allow the easy switch of involatile to compatible mobile phases for detection using MS.

## Multi-Dimensional LCMS



**CLICK HERE**

### Screening Analysis of Highly Polar Doping Agents in Urine Using Trap and Elute 2D-LC-MS/MS

Flow Diagram of 2D-HILIC System

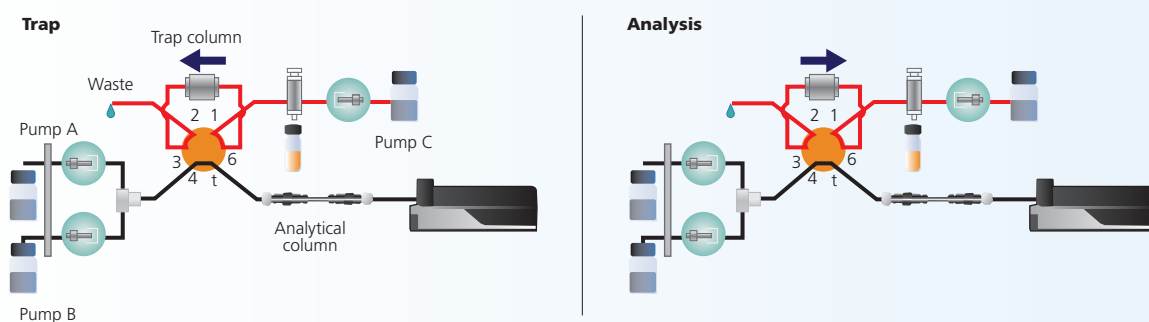

**CLICK HERE**

### Analysis of Impurities in Pharmaceutical Ingredients Using Trap-Free 2D-LC-MS/MS

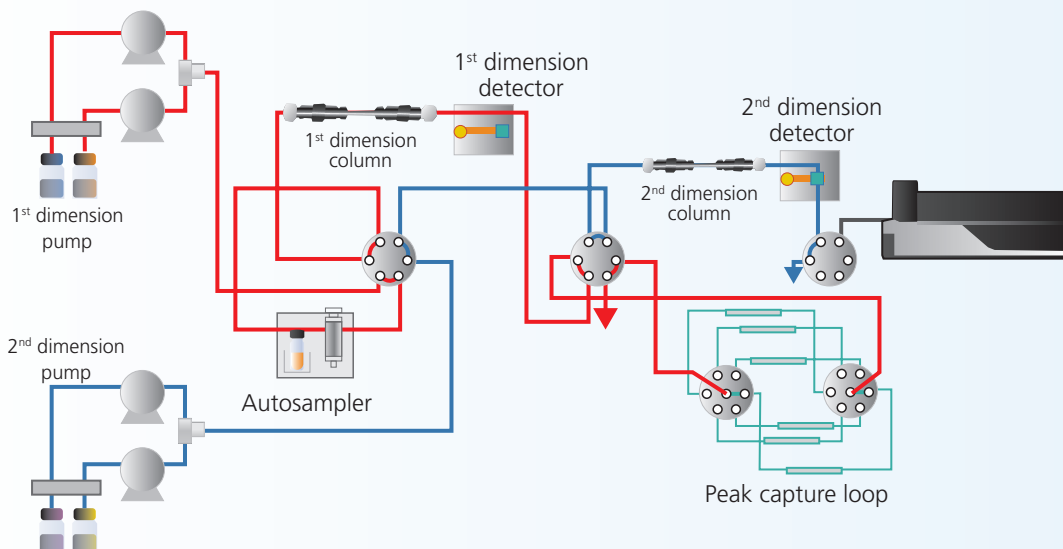

## Interfaces for LCMS

MS require ions to be in the gaseous phase and these ions are detected under high vacuum in the MS. In the case of GCMS, target compounds are already separated and eluted in the gaseous state. In this case, they can be directly introduced to the MS unit. The gaseous compounds are ionized through various methods such as electron ionization (EI) and chemical ionization (CI).

In EI, gaseous analytes are passed through a curtain of high-energy electrons where electron impact induces ionization of compounds. This high energy ionization fragments the compounds to produce ions of smaller  $m/z$ . This is considered a 'hard' ionization due to the high degree of fragmentation. The higher the

energy provided, the larger the degree of fragmentation. Figure 6 shows the difference in the mass spectrum of riboflavin (vitamin B<sub>2</sub>) when it undergoes EI versus when it undergoes a 'soft' ionization like ESI, where the molecular ion and its adducts are commonly observed. Given that the energy provided by EI is uniform (e.g. 70 eV), the electron ionization and fragmentation process is very reproducible, generating the same fragment ion species at pre-determined intensity ratios. For this reason, the mass spectra produced by EI is commonly used to identify unknown samples and peaks by matching acquired spectra to the spectrum library contained in the compound database.

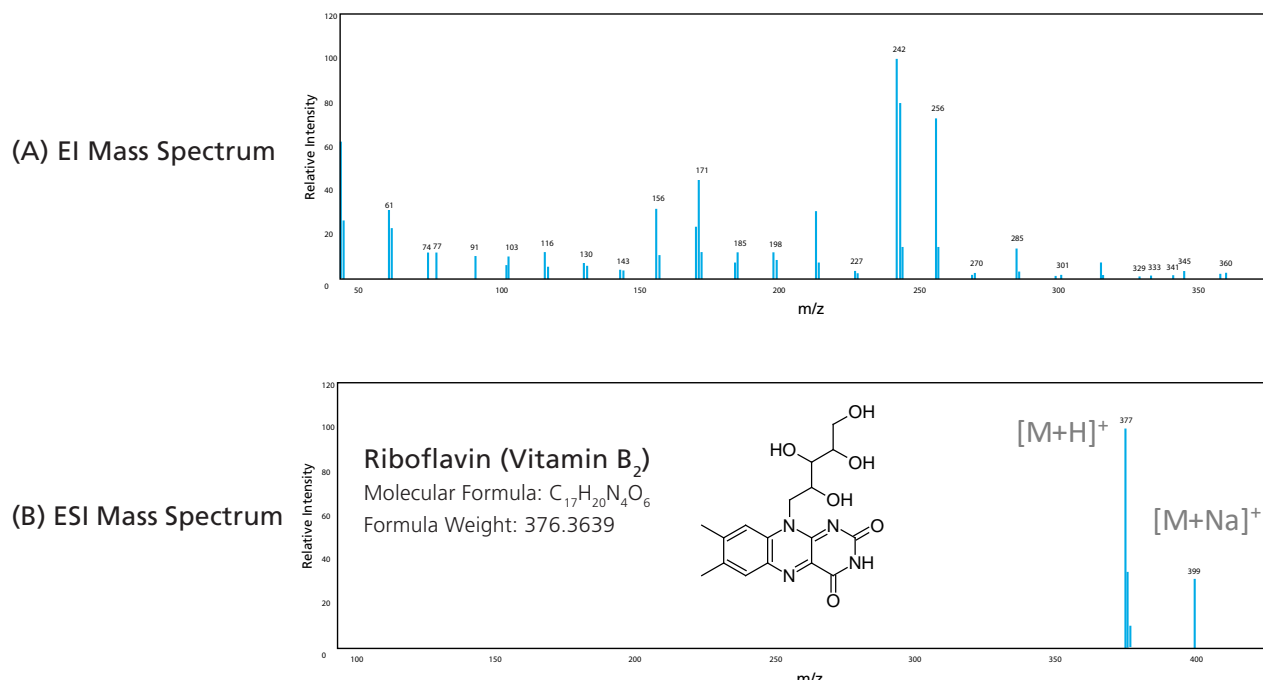

However, EI is considered not applicable to LCMS. In the EI chamber, high-energy electrons used for ionization are produced by passing a current through a metal filament in high vacuum. With LCMS, the LC flow is incompatible with the high vacuum system required in EI and the heating of the metal filament at atmospheric conditions causes it to burn and evaporate (e.g. oxidation of tungsten filament at high temperature). As a result, the use of EI in LCMS is not suitable due to the vastly different conditions that they each operate in, which ultimately created mechanical difficulties and interfacing issues. Therefore, it is crucial to have an interface to connect the LC outlet to the MS inlet that can efficiently transfer the LC mobile phase to gas and at the same time ionize the analytes.

Various interfaces for LCMS were developed, but issues with sensitivity, stability and user-friendliness were faced. After further improvements and developments, API, a type of soft ionization technique, proved to be well-suited for use in LCMS. As its name suggests, it ionizes compounds under atmospheric pressure conditions, which makes it especially useful for removing solvents outside a vacuum. API serves as both the ionization source and the interface in a LCMS system. In general, ions generated by API are stripped of solvent, focused into a beam using an ion guide, and finally introduced into the mass analyzer. Three API techniques are described here, namely the electrospray ionization (ESI), atmospheric pressure chemical ionization (APCI) and atmospheric pressure photoionization (APPI).

## Electrospray Ionization (ESI)

ESI generates ions by first drawing and spraying sample solutions at the tip of a capillary tube, where a high voltage of about  $\pm 3$  to 5 kV is applied. This generates a fine mist of charged droplets with the same polarity as the applied voltage. To accommodate a larger LC flow rate, the nebulizer and heating gas flows from outside the capillary to speed up the solvent evaporation process. As this process continues, the electric field on the droplet surface increases. When the mutual repulsive force of the charges exceeds the liquid surface tension (i.e. repulsion), fission occurs. It is thought that as this evaporation and fission cycle is repeated, the droplets eventually become small enough that the sample ions are liberated into the gas phase (based on the ion evaporation model). A schematic representation of the generation and desolvation processes in ESI for positively charged ions are illustrated in Figure 7. Similarly, negatively charged ions are generated by applying a negative voltage on the ESI probe.

ESI is one of the softest ionization methods available, which means fragmentation is minimal and it can be used for highly polar, least volatile, or thermally unstable compounds. Since most of the compounds result in protonated (or deprotonated) molecular ions and adduct ions, without generating complicated fragment ions, determination of the molecular mass of compounds is very simple.

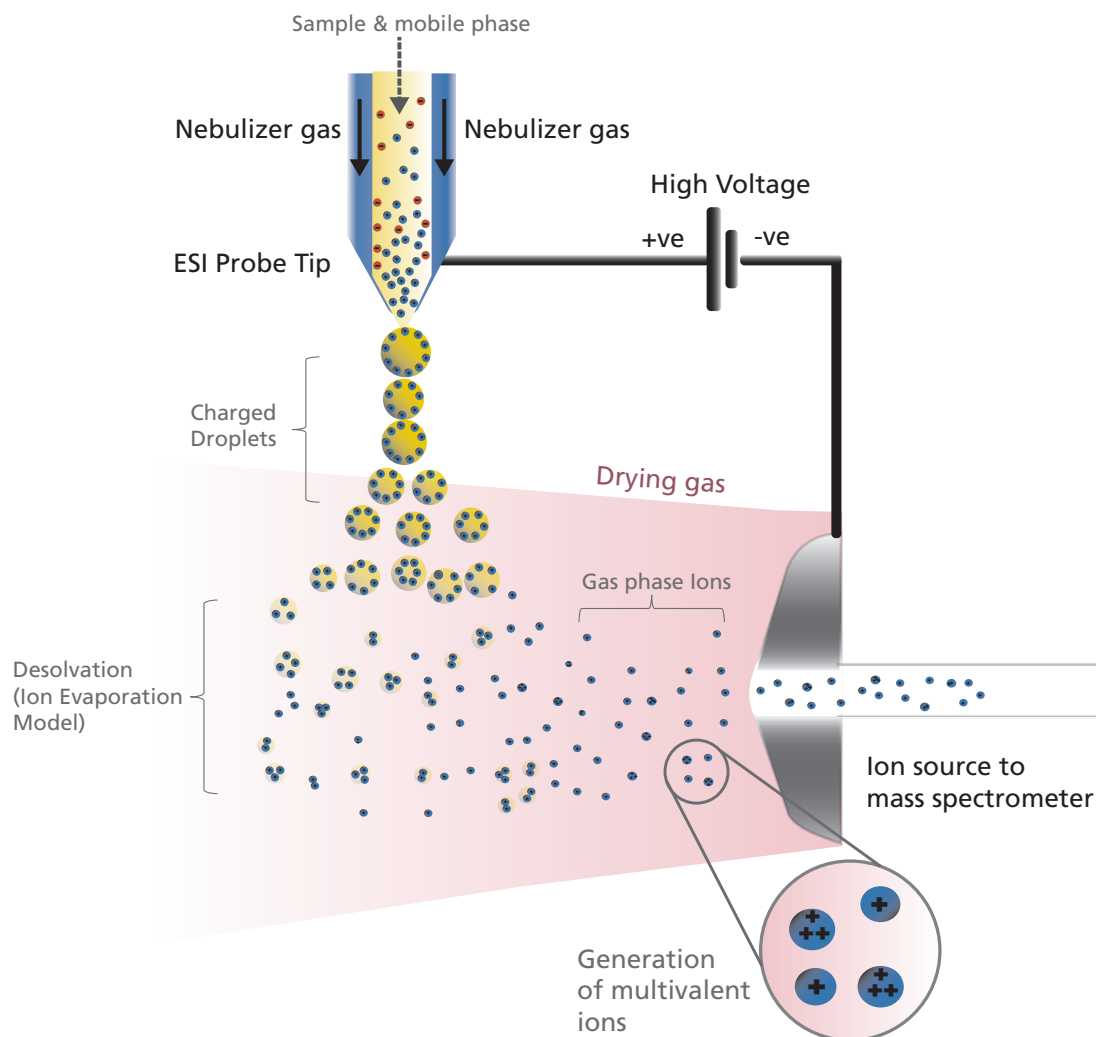

**Figure 7.** Schematic of the ionization and desolvation processes in ESI positive (+) mode.

In addition, ESI is known to occasionally generate molecular ions with multiple charges for compounds that have several potential charge-accepting functional groups. In the case of cations, this means multiple protons are added to form  $[M + nH]^{n+}$ . The tendency to form multivalent ions is strongly influenced by the  $pK_a$  of the compound relative to the pH of the solution. When the multivalent ion is observed, molecular mass information can be obtained even for compounds with a molecular mass that exceeds the measurement range of the

mass spectrometer. It is also possible to use computer processing to predict the molecular mass from those multivalent ions. An example of myoglobin is illustrated in Figure 8. For myoglobin, ions with valences ( $n$ ) from 10 to 20 were detected and molecular mass was calculated by deconvolution to be 16951.3. This uniqueness of ESI-LCMS allows the analysis and measurement of extremely large and highly-polar biological macromolecules, such as proteins and nucleic acids. This is vastly different from GCMS, which usually only provides peaks of  $z = 1$ .

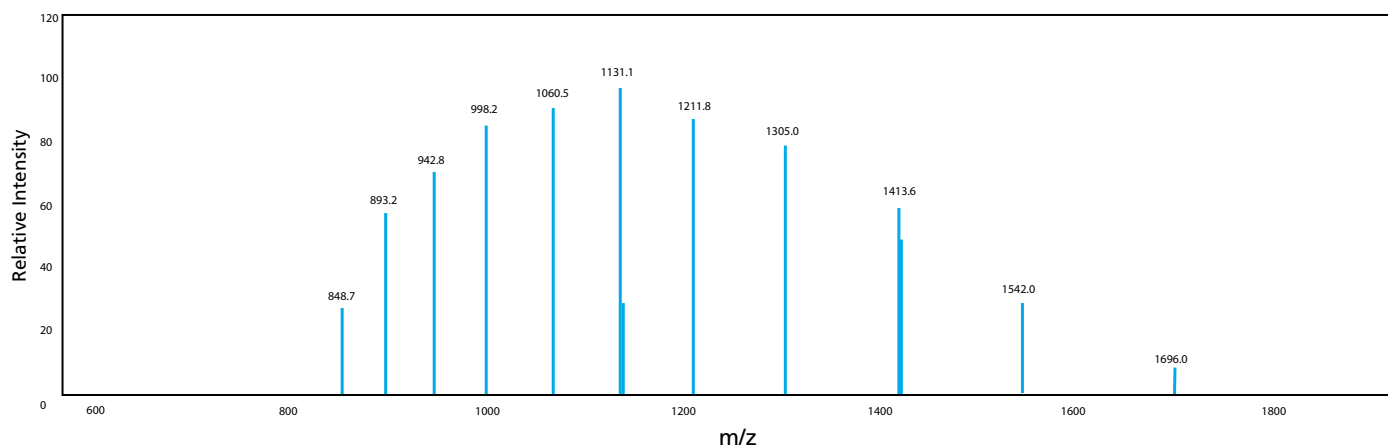

**Figure 8.** Molecular mass of myoglobin calculated using ESI spectrum and deconvolution, multivalent ions ( $n = 10$  to  $20$ ) of myoglobin is observed in the ESI mass spectrum.

### Atmospheric Pressure Chemical Ionization (APCI)

The other API technique is APCI, which is a type of chemical ionization. Though the interface design is similar to ESI, the ionization principle differs, making it more suitable for low- and medium-polarity compounds (non-polar molecules). As illustrated in Figure 9, APCI vaporizes the solvent and sample molecules by spraying the sample solution into a heater (about 400 °C) using a gas, such as  $N_2$ . Solvent molecules are ionized by the corona discharge needle to generate stable reaction ions. Protons are transferred between these stable reaction ions and sample molecules (ion-molecule reaction) and this leads to ionization. These ion-molecule reactions are known to involve several patterns, such as proton-transfer reactions and electrophilic addition reactions. Unlike ESI, APCI involves a higher energy process and does not have the tendency to form multiply-charged ion  $[M + nH]^{n+}$ . Consequently, it is commonly used for analyzing highly fat-soluble compounds or compounds that do not ionize in solution.

### Atmospheric Pressure Photoionization (APPI)

APPI ionizes analytes by irradiation of short-wavelength vacuum ultraviolet (VUV) light. The interface design in APPI (Figure 10) is very much the same as APCI, only with the swap of the high-voltage corona discharge needle to the VUV lamp. Similarly, the nebulizer and heater are used to create droplets and to vaporize the solvent. Upon VUV light irradiation, the analytes absorb a photon and get electronically excited. If the analyte's ionization energy is lower than the photon energy, the analyte ion that was ionized due to the photons may receive a proton from the hydrogen in the solvent, to become a protonated cation. This ionization technique achieves good sensitivity ionization with low to moderate polarity compounds (e.g. polycyclic aromatics).

In summary, ions can be generated through either the continuous or pulsed (discontinuous) modes. The three API techniques (ESI, APCI and APPI) that were introduced operates in the continuous mode, giving a constant flow/supply of

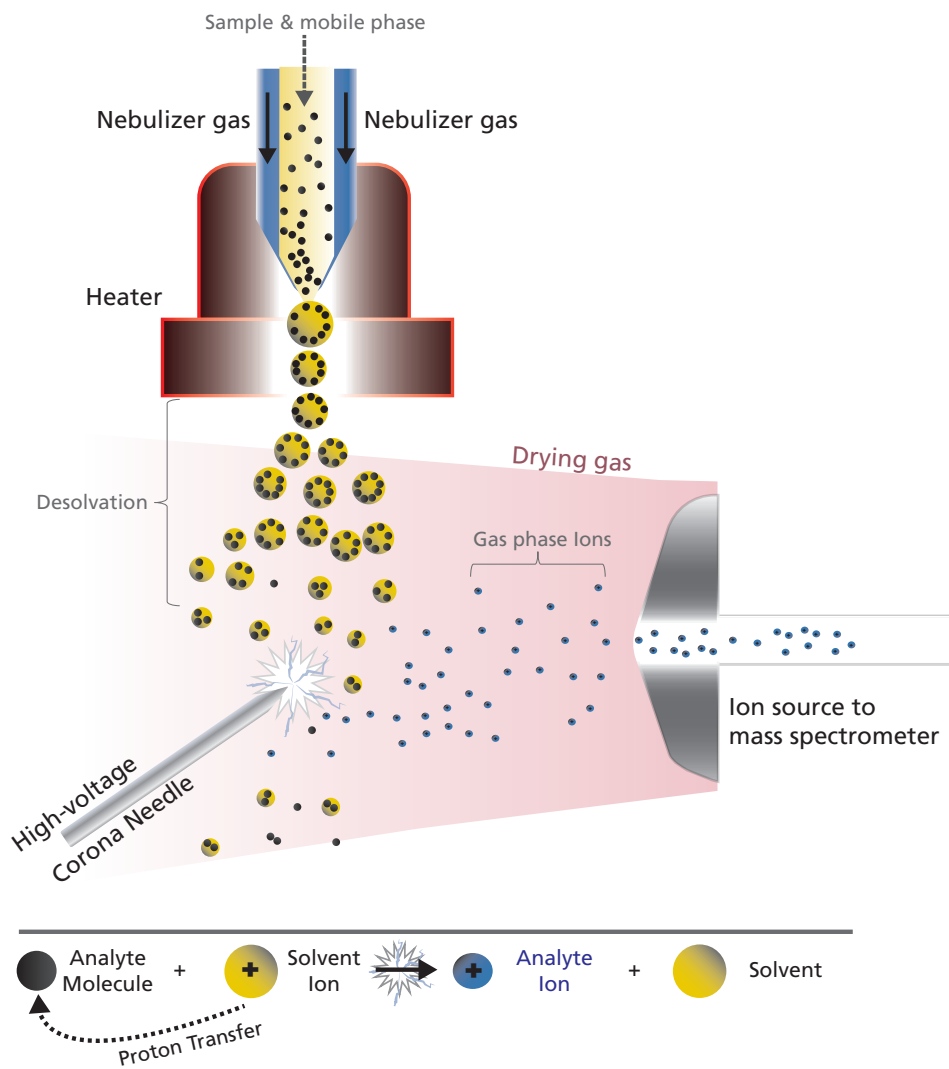

Figure 9. Schematic of the ion-molecular reaction (e.g. proton transfer) in APCI.



[CLICK HERE](#)

**Understand more about the principles of MALDI, a discontinuous ionization source suitable for coupling to MS.**

This technique is commonly used for the identification and analysis of large biomolecules (e.g. structural characterization of proteins).

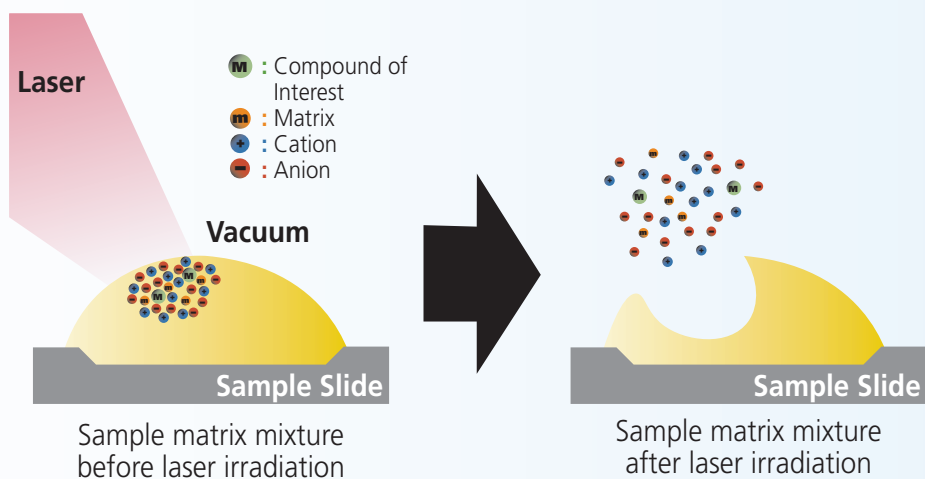

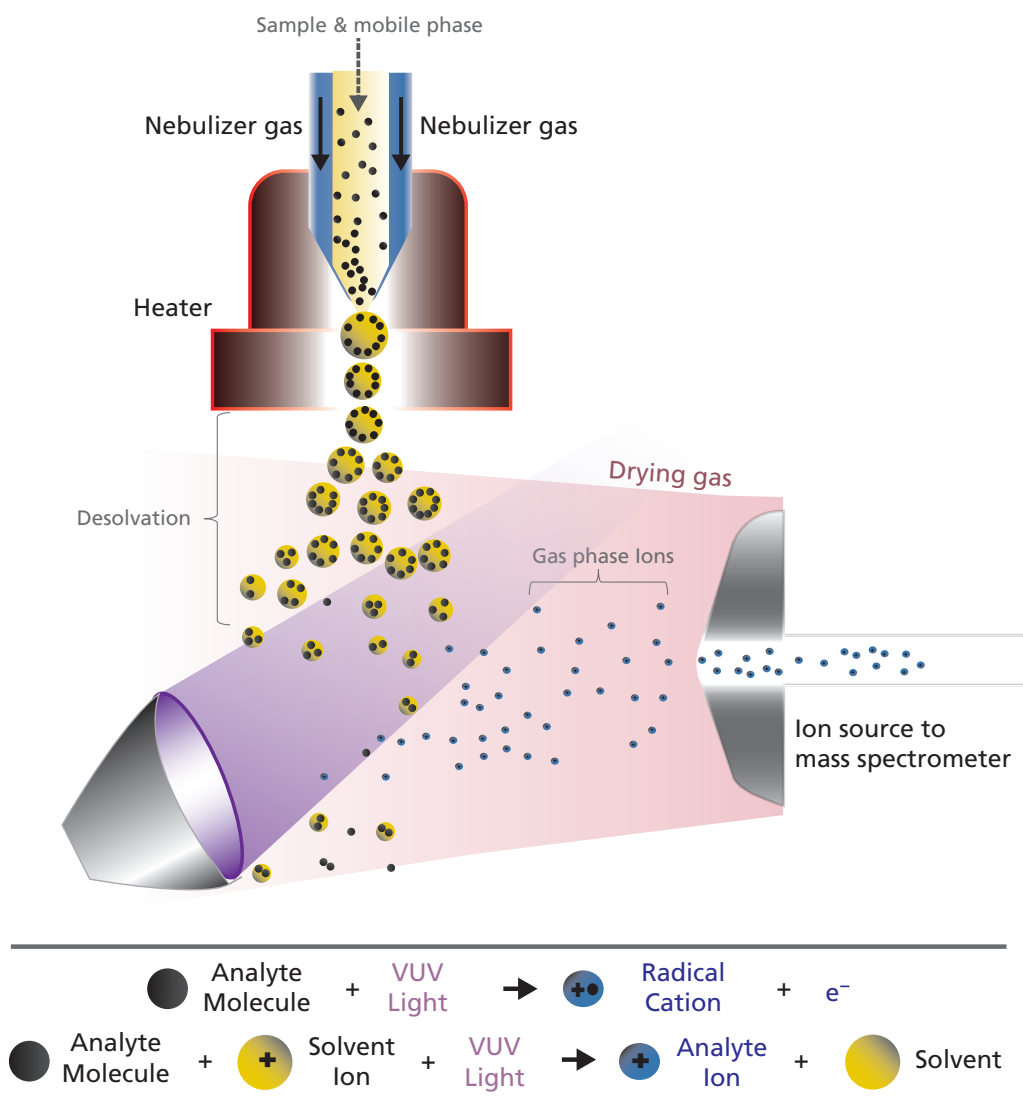

Figure 10. Schematic of the ionization process by UV light in atmospheric pressure photoionization (APPI).

ions to the MS. On the other hand, the pulsed mode generates a discontinuous source of ions such as the Matrix-Assisted Laser Desorption/Ionization (MALDI). In this section, we introduced the LCMS components and discussed the principles of

the various API options for LCMS interface. Next, we examined the efficiency of these ionization processes and the importance of selecting appropriate analytical conditions for LCMS.



## Overview of Atmospheric Pressure Ionization (API)

Several parameters affect the efficiency and sensitivity of these API processes (i.e. ESI, APCI and APPI). Apart from the instrument specifications and parameters, the limiting factors are:

- Flow rate of LC or liquid inlet
- Solvents / mobile phases (e.g. types, pH and additives used)
- Properties of analytes (e.g. volatility, thermal stability and ability to form charged species)
- Matrix effects (e.g. suppression and enhancement)
- Output from LC (e.g. peak width)

Flow rate is one of the key parameters to achieve high sensitivity, especially for ESI. In LCMS, a semi-micro (2 mm internal diameter (ID)) LC column is preferred over the conventional (4.6 mm ID) LC column commonly used in HPLC. Using a smaller ID column, the optimum flow rate for chromatographic separation is lower, and lower flow rate generally increases the ionization efficiency of ESI. For this reason, a standard ESI ionization unit is designed to achieve an optimal sensitivity for the flow rate of 0.2-0.8 mL/min and sensitivity is typically compromised at higher flow rates.

Next, changes made to the mobile phases such as the types and pH of mobile phases and using additives can particularly affect the sensitivity of these API. Particularly for ESI, the formation of droplets and ions

is crucial to achieve high sensitivity. It is important to obtain extremely fine droplets and liberate ions from these droplets by reducing droplet surface tension and optimizing droplet pH. For example in Equation 1, a basic compound (R-NH<sub>2</sub>) is commonly detected as positive ions [R-NH<sub>3</sub>]<sup>+</sup>. By adding an acidic reagent (AH), it shifts the equilibrium to the right, which increases the production of the positive ions and thereby increases sensitivity. In general, a desired mobile phase has a pH value 1 or 2 lower than the pK<sub>a</sub> value of the sample. Conversely, for acidic compounds (Equation 2), sensitivity can be increased by adding a basic reagent (B) or by using a mobile phase with a higher pH than the sample pK<sub>a</sub>. In the case of neutral compounds without an ionic functional group, adding a volatile salt such as ammonium acetate can sometimes increase ionization efficiency as adduct ions.

Equation 1:

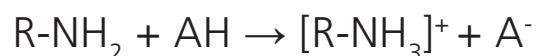

Equation 2:

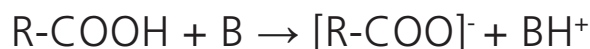

In addition, it can be effective to increase the proportion of organic solvent to reduce surface tension and accelerate solvent evaporation. If using these additives affects the LC separation, the solution can be added post-separation (prior to MS analysis) as well.

In the case of APCI, it requires analytes to be thermally stable and volatile. It is ideal for the ionization of low to medium molecular mass compounds (e.g. polyaromatic hydrocarbons, carbohydrates and triglycerides) but not suited for macromolecules due to high boiling point. Ionization efficiency of APCI is governed more by the chemical property of solvent than analyte. APCI requires that the solvent is protic, i.e. has sufficiently high proton affinity to display hydrogen bonding, for it to mediate ionization of the analyte. If the use of a protic solvent is not suited for chromatographic separation, other non-protic solvents may be used with a few percent of protic solvent added to assist ionization. In general, APCI can be used in reversed-phase, normal phase and size exclusion modes and is less affected by salts compared to ESI.

For APPI (Figure 11), sensitivity can sometimes be increased by adding

a compound (dopant), which has lower ionization energy than the analytes. The dopant facilitates and increases the ionization of the analytes, thereby increasing the sensitivity.

In general, the selection of API techniques in LCMS is based on the analytes' polarities and properties. Table 2 summarizes the analyte properties required for the three API techniques. These API techniques can be further optimized by varying the mobile phases and flow rate to reduce matrix effects and improve efficiency and sensitivity. As described (Figure 4), ESI is generally selected for high-polarity compounds which can be typically found in drugs and pesticides, while APCI and APPI are usually selected for compounds having lower polarity, such as polycyclic aromatics and mycotic toxins.

In the event where analysis of multiple components with differing polarities and properties is required, some samples may need to be analyzed by multiple settings to

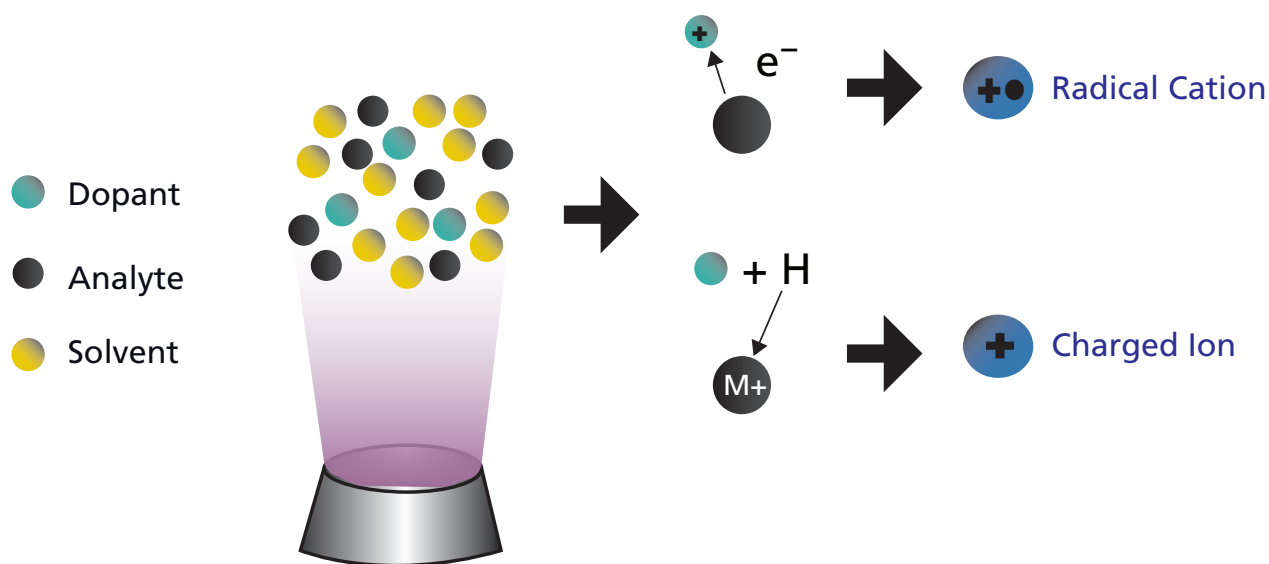

Figure 11. Illustration of the use of dopant to increase sensitivity in APPI.

**Table 2.** Summary of ionization process and analyte properties of API techniques.

API techniques	ESI	APCI	APPI
Ionization process	Ions in solvent transition to gas phase by electrospray	Ionization occurs in gas phase by corona discharge	Ionization occurs in gas phase by UV irradiation
Types of ions formed	Singly charged ions Multiply charged ions	Singly charged ions	Singly charged ions
Volatility of analyte	Do not need to be volatile	Require some degree of volatility	Require some degree of volatility
Stability of analyte	Do not need to be thermally stable. Can be thermolabile.	Must be thermally stable	Must be thermally stable

cover the entire range of compounds. To shorten the total time required for analysis and method development, and to improve both laboratory efficiency and confidence in results, Shimadzu have developed the Dual Ion Source (DUIS) that enables simultaneous

ESI and APCI. With this technology, it gives higher sample throughput where the both ionizations (i.e. ESI and APCI) can be completed in a single run.



**CLICK HERE**

### Dual Ion Source (DUIS)

for simultaneous ESI and APCI measurement

#### MS Chromatograms

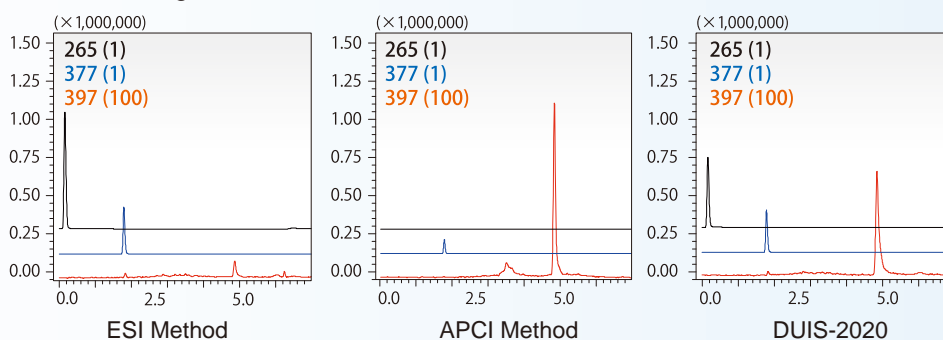

## Mobile phases compatible for LCMS

As MS operates in high vacuum, it is necessary to ensure that the LC parameters and mobile phases (liquid inlet) are compatible to MS. Usually when switching from LC to LCMS analysis, the current LC conditions can be used if the mobile phase is volatile. If involatile (e.g. phosphate buffer), modifications (e.g. chromatography mode, column, type and volatility of mobile phase) is required. This should be investigated step-by-step to allow better interfacing with

LCMS. As mentioned in Chapter 1, there are a variety of separation modes for LC (Table 1) and the types of stationary phase and mobile phase can be modified based on sample characteristics, the desired level of separation, ionization level and MS compatibility.

A great starting point would be to use volatile mobile phases. A list of mobile phases suitable for API and LCMS are summarized in Table 3. In addition to the fundamental

**Table 3.** Mobile phases suitable for API interface and LCMS.

Fundamental Mobile Phase Solvents	pH Adjusting Reagents (volatile, $\leq 10\text{mM}$ )
a) Alcohols (e.g. methanol, ethanol, propanol) b) Acetonitrile (ACN) <sup>1</sup> c) Water (pH adjusted, if necessary)	<u>Acids</u> a) Acetic acid b) Formic acid c) Trifluoroacetate (TFA) <u>Base</u> d) Aqueous ammonia <u>Buffers</u> e) Ammonium acetate f) Ammonium formate
Relatively Volatile Ion Pair Reagents <sup>2</sup>	Usable Organic Solvent <sup>3</sup>
To retain basic compounds a) Perfluorocarbonate, C2 to C8  To retain acidic compounds b) Dibutylamine, c) Triethylamine (TEA)	a) Dimethylsulfoxide (DMSO) b) Dimethylformamide (DMF) c) Tetrahydrofuran (THF) d) Acetone e) Esters f) Chloroform g) Benzene h) Hexane

<sup>1</sup> Acetonitrile is not compatible with APCI due to the reduction of nitrile to carbon for negative ionization. In this case, methanol should be used instead.

<sup>2</sup> Use minimally as these substances can remain in the LC and MS system even after changing mobile phase. It is necessary to flush the LC system to remove any traces of these ion-pairing agents.

<sup>3</sup> If a "fundamental mobile phase solvent" is present, it usually does not pose a problem if the mobile phase contains some of these organic solvents. (However, the ionization effect decreases as the concentration of usable organic solvents increases.)

mobile phases such as water, methanol and acetonitrile, acetic acid is also commonly used to adjust the pH level. For buffer solutions, volatile salts such as ammonium acetate and ammonium formate are used. Also, volatile ion-pair reagents can be added to the mobile phase to facilitate the separation of polar compounds using reversed-phase LC. These reagents, which have a long hydrophobic tail and a polar ionic group, tend to attach to the stationary phase of the column with the ionic group sticking out. In the presence of ion-pair reagents, polar compounds interact with the charged ionic groups of the ion-pair reagent and gets retained and separated in the reversed-phase column. With focus on the ionization efficiency, protic solvents are essential for generating reaction ions for APCI, and polar solvents are essential for ESI since they are required to dissolve polar or ionic compounds.

A key point to note is involatile salts, such as phosphate buffer solution, is not suitable for use in LCMS. Involatile salts form precipitates at the LCMS interface, which immediately causes sensitivity drop by affecting the electrical fields applied for ionization and ion transfer. It can further cause physical damage, such as contamination on the needle electrode for APCI or by inducing electrical discharge (spark). Also, nonpolar solvents, such as hexane, contribute very little to ionizing sample molecules using APCI. Therefore, analytical conditions that use such mobile phases cannot be used without modification.

In the event that they may be limitations to the mobile phase choices and changing

may pose a challenge to the LC separation, post-column addition or modifications (prior to MS) may be a good alternative. In addition, there is the trap-free 2D-LC-MS/MS technique that can be used to change the mobile phase to ensure compatibility with MS. Also, better LC separations and easier interfacing to LCMS can be achieved by switching the type of LC columns. For example, if the C18 (octadecyl) column for reversed-phase mode is used, we can try switching to C30 column to increase retention or C8 or C4 to reduce retention, or -phenyl or -CN column to increase separation selectivity. If the difference in elution times is too great or peaks are too broad, gradient elution program can be utilized. If the mobile phase and salt concentration are suitable for API, then different chromatography mode (e.g. size exclusion or ion exchange) can be used as well.



**CLICK HERE**

#### **Practical Tips for LCMS Analysis**

We have collated additional tips and more in-depth discussion on LCMS method development and analyses.

In summary, this chapter covered the basic components of a LCMS system and the various ionization methods used in LCMS. The factors that limit the sensitivity of the API techniques and the need to select appropriate analytical conditions for LCMS are discussed to aid in your analyses and give a better understanding of the LCMS interface.

# Chapter 3

## Principles of MS

Thus far, we have only described MS as a method used to measure the mass of atoms and molecules, but how does it measure mass? Many types of mass analyzers are available depending on the method preferred to separate ions. In this chapter, we shift our focus to MS and describe the principles and key features of these mass analyzers.



## Introduction to mass analyzers

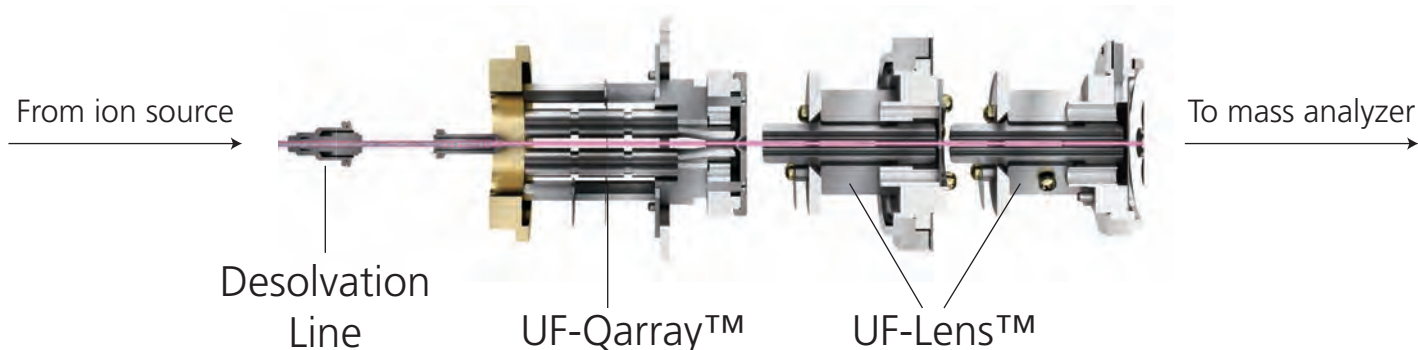

Figure 12. Schematic of Shimadzu's ion optical system (e.g. ion guide).

Mass spectrometry involves the control of ion movement by applying electrostatic fields. Ion optics is the term given to this electrostatic manipulation of ion flow in analogy with light manipulation by optical lenses. Figure 12 presents Shimadzu's ion optics system. It is used to focus the ions generated at the ion source into a beam. Simultaneously, it removes non-ionic gas particles from the system by progressive pumping and partitioning. This is important for achieving high-sensitivity analysis as residual particles interfere with the ion beam. Ion transmission and focusing is achieved by applying the required electric fields or radiofrequency voltage at the quadrupole ion guide.

How does the mass analyzer work? Normally when we measure mass ( $m$ ), we use a mass scale or balance, which relies on the Earth's gravity. So, how do we measure the mass of a molecule, which is so extremely small that its gravitational force is almost too small to measure? The first occurrence

started in 1912, where the English physicist, J. J. Thomson, utilized the fact that the flow of charged particles bends in an electric or magnetic field to develop an instrument that could separate charged particles by its mass number. In his instrument, which used a cathode ray tube, cations with identical ratios of charge ( $z$ ) and mass ( $m$ ) converged along the same parabola. When he measured the neon (Ne) gas molecule, the parabolas for  $^{20}\text{Ne}$  and  $^{22}\text{Ne}$  (both are monovalent cations) were slightly different, which proved the existence of isotopes. Therefore, with the use of this electromagnetic interaction, ions



**CLICK HERE**

### Development of UF-Qarray: RF Ion Guide with Improved Ion Focusing Capability

Learn about the specifics of Shimadzu's high frequency quadrupole ion guide (Qarray). It is designed to enhance ion focusing and minimize contamination.

can be separated and measured according to  $m/z$ .

There are a variety of mass analyzers and they can be classified by how the ions are being introduced such as continuous or pulsed modes. Continuous MS allows an uninterrupted supply of ions to enter the mass analyzer while pulsed MS requires the ions to be introduced only at a specific time point. In a pulsed MS, ions from a continuous flow are usually accumulated and introduced together in pulses.

Apart from a single MS, there are tandem/hybrid arrangements, also known as MS/MS systems. Single mass analyzers such as the magnetic sector, quadrupole, and time-of-flight (TOF) were commonly used for measuring organic compounds, but the quadrupole model has gradually been increasing their share due to its relatively lower cost. Besides these mass analyzers, an ion trap MS system that temporarily accumulates ions of a selected range before separating them by mass, and a tandem/hybrid MS system that combines multiple MS units have been developed as well. These types of MS systems each take advantage of their respective features and are used

according to various analytical objectives. This chapter elaborates on the separating and operating principles of the single mass analyzers and compares the characteristics, pros and cons for each of these mass analyzers.

### Magnetic sector MS

Magnetic sector, a continuous MS, has been used historically the longest. As the name implies, the mass analyzer uses magnetic field to separate ions of different  $m/z$  values (Figure 13). High voltage is first applied to the ions to accelerate them into the magnetic sector. A continuous ion source is generated and supplied from the ionization unit to the magnetic sector. Once the ions enter, are exposed to the magnetic field. As a result, ions are deflected according to Fleming's left-hand rule<sup>4</sup>. The deflections differ based on their  $m/z$  where lighter ions (of the same charge) will experience more deflection.

<sup>4</sup> Fleming's left-hand rule can predict the direction/force of the movement when there is an electric current moving in an applied magnetic field. As a result, ions are accelerated in a direction perpendicular to the current and magnetic field, resulting in a curved deflection path for the ions in the magnetic sector MS.

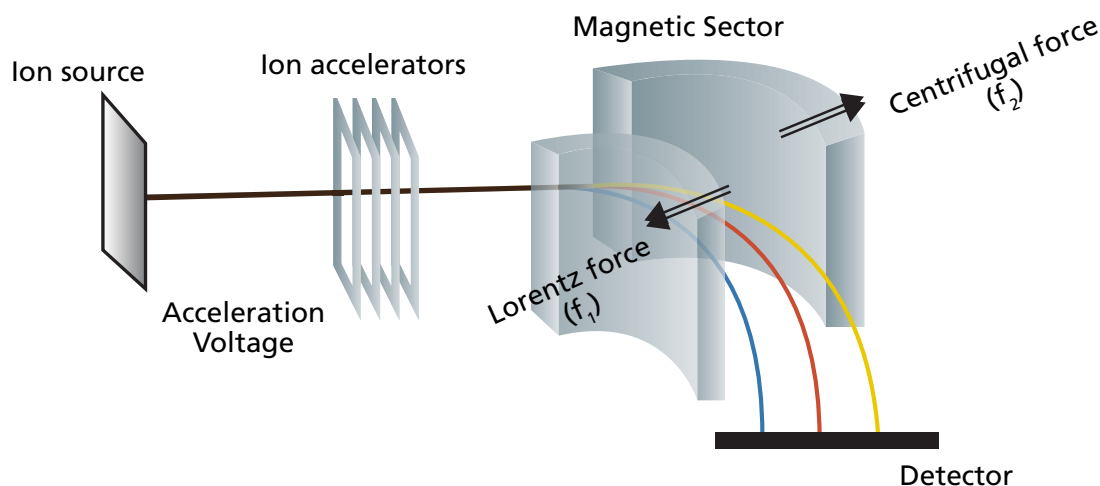

Figure 13. Schematic of magnetic sector MS.



Equation 3:

$$f_1 = Bzev$$

Equation 4:

$$f_2 = \frac{mv^2}{r}$$

Equation 5:

$$f_1 = f_2 = Bzev = \frac{mv^2}{r}$$

Equation 6:

$$KE_{\text{ion}} = \frac{1}{2} mv^2 = zeV$$

Equation 7:

$$\frac{m}{z} = \frac{eB^2r^2}{2V}$$

B: magnetic flux density

z: charge of the ion

e: elementary charge

v: velocity of the ion

m: mass of the ion

r: path radius

V: acceleration voltage applied to ions

Ions experience a Lorentz force ( $f_1$ ) from the magnetic field that can be calculated according to Equation 3. As the direction of the ion changes, a centrifugal force ( $f_2$ ), expressed by Equation 4, acts on the ion. For the ions to pass through the magnetic field region and reach the detector, it must travel along a curved path of a given radius ( $r$ ) where  $f_1$  and  $f_2$  are balanced (Equation 5). Furthermore, the kinetic energy of ions accelerated by voltage  $V$  is shown in Equation 6. By eliminating the velocity of the ion ( $v$ ), Equations 5 and 6 are simplified to give Equation 7. By keeping the ion acceleration voltage  $V$  constant and varying the magnetic flux  $B$  (or keeping  $B$  constant and varying  $V$ ), a detector placed on the corresponding path radius  $r$  could detect any mass  $m$  (given the same charge).

In reality, only one ion detector is used and both the acceleration voltage ( $V$ ) and curve path radius ( $r$ ) are kept constant while the magnetic flux density ( $B$ ) is scanned. This means that ions with different masses ( $m$ ) all pass along the same path through the magnetic field, one after another, and reach the detector. One mass spectrum is obtained from each scan of the magnetic field. That is to say that magnetic sector mass analyzer function by ion transmission and scanning mode. Besides the described single magnetic sector MS, there are also models of MS with both the electric sector and magnetic sector in a single MS, which is known as a dual-focusing MS. This setup is able to focus and converge ions of different energy and identical mass thereby obtaining

higher mass resolution.

Some of the key features of magnetic sector MS are its high resolution and high dynamic range. The measurement range of magnetic sector MS systems typically is about 10 to 10,000, though it depends on the acceleration voltage  $V$  and instrument design. Resolution of about 2000 can be obtained using a single-focusing magnetic sector model or several tens of thousands using a dual-focusing magnetic sector model. Before the recent introduction of the high-performance time-of-flight (TOF) MS and ion-cyclotron-resonance (ICR) MS systems, the dual-focusing magnetic sector spectrometer was the only MS capable of such high-resolution measurements.

However, to improve the performance of the magnetic sector MS, the strength of the magnetic field needs to be raised which means costly and larger systems are required. This limits the development of the magnetic sector MS. In addition, magnetic sector MS systems require an extremely high vacuum level of  $10^{-7}$  Pa, causing difficulty in the LCMS interface. Furthermore, they have the disadvantage of a slower scan speed than other MS systems. Therefore, these

mass analyzers are now rarely used in LCMS systems. On the other hand, they interface relatively easily to a GC unit. Consequently, such GC-MS systems are used for dioxin analysis due to the outstanding high-resolution selected ion monitoring (HR-SIM) capability of magnetic sector MS.

### Quadrupole MS

The other MS which functions by scanning of ions and allowing ion transmission is the single quadrupole mass analyzer. As its name suggests, it contains four parallel cylindrical metal rods (electrodes with a hyperboloidal interior surface) inside a vacuum chamber, positioned equidistant from the center axis (Figure 14). Both a direct current (D.C.) and high frequency alternating current or radiofrequency (RF) are applied to the quadrupole, so that only the ions with the target  $m/z$  successfully pass through the quadrupole and get to the detector. The quantity of ions that reach the detector is converted to a signal and output to a computer.

Continuous ion source generated in the ionization unit are first accelerated in the  $z$ -direction (Figure 14, green arrow) by a relatively weak voltage of only a few

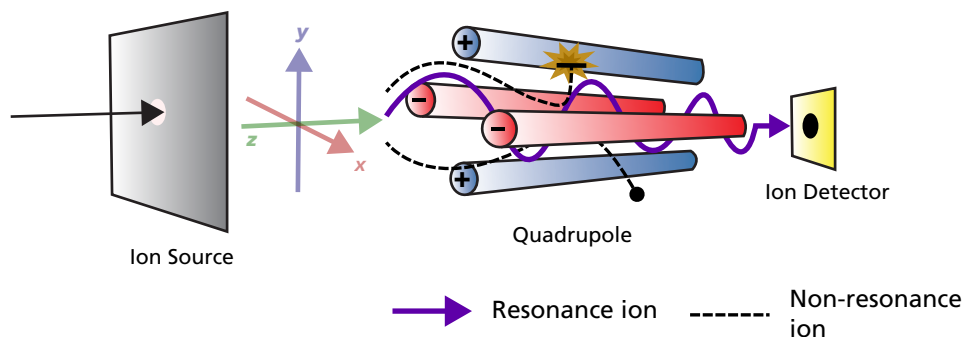

Figure 14. Schematic of how Quadrupole MS works.

dozen volts. These ions pass through a tiny orifice and enter the quadrupole. Voltage of the same polarity is applied to diagonally-opposite poles and opposite voltage polarity is applied to adjacent poles as depicted by the blue and red rods in Figure 14. When a combination of the direct current voltage and high-frequency alternating current voltage is applied to each pole, an electric field with a rapidly varying phase is generated within the quadrupole.

Consequently, ions passing through this electric field oscillate in the  $x$ - and  $y$ -directions. When a given set of parameters are applied to the poles, certain ions of a specific  $m/z$  range maintain a stable oscillation and pass through the quadrupole to reach the detector (Figure 14, resonance ion). On the contrary, the oscillations of ions with other  $m/z$  values become unstable, causing them to collide with the poles, fly out of the system, and not be detected (Figure 14, non-resonance ion).

The oscillation of ions within the quadrupole MS is known to occur according to the Mathieu Equation (Equation 8). The motion of the ion in a quadrupole follows this equation regardless of its initial velocity or position. Figure 15 illustrates how the equation is solved which is also the Mathieu stability diagram for the stable regions for ions in a quadrupole MS system.

As illustrated in the shaded areas in Figure 15, the conditions required for stable ion oscillation are determined by the mass and oscillation frequency of the ion as observed in the Mathieu Equation.

## Equation 8: Mathieu Equation

$$\frac{m}{z} = K \frac{V}{r^2 \omega^2}$$

$m$ : mass of the ion

$z$ : charge of the ion

$K$ : constant

$V$ : voltage applied

$r$ : effective distance between the electrodes

$\omega$ : oscillation frequency

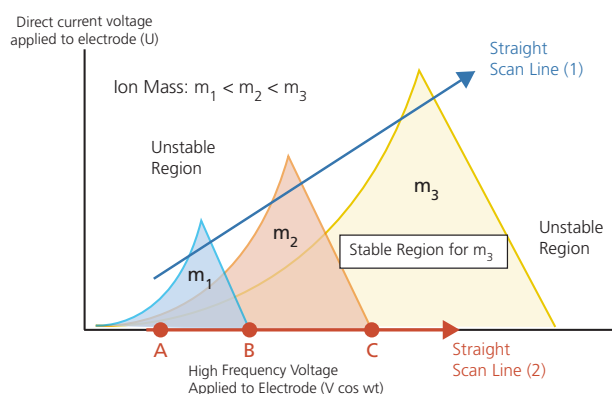

**Figure 15.** Mathieu stability diagram for the stable regions for ions in Quadrupole MS system.

The region of stability is different for ions with masses  $m_1$ ,  $m_2$  and  $m_3$ . If the voltage is varied while keeping the ratio between the direct current voltage ( $y$ -axis) and high-frequency alternating current voltage ( $x$ -axis) constant, a straight scan line 1 is obtained. This scan line passes through respective regions of stability for ions with masses  $m_1$ ,  $m_2$  and  $m_3$ . Consequently, these ions are passed through the quadrupole consecutively in the same order ( $m_1$ ,  $m_2$  and  $m_3$ ). In this way, a mass

spectrum is obtained for ions with masses ranging from small to large.

For a single quadrupole MS system, it can operate in two modes: (A) Scan and (B) Selected Ion Monitoring (SIM). In scan mode, the voltages to the quadrupoles is configured such that the entire mass range specified is scanned sequentially with appropriate dwell time<sup>5</sup> for each  $m/z$  value. As illustrated in Figure 16A, the blue ions, followed by red ions and lastly yellow ions passed through the quadrupole sequentially and gets detected. The result is a record of the ion abundance

in the specified range of the mass spectrum. For the SIM mode (Figure 16B), only the selected  $m/z$  (red ion) is monitored, passed through the quadrupole and detected. This SIM mode offers higher sensitivity and avoids the effects of unwanted analytes and impurities.

<sup>5</sup> Dwell time is the time allocated for measuring or acquiring the data of an ion of a particular mass-to-charge ratio in a mass spectrometer. It is the acquisition portion of the LCMS duty cycle. The longer the dwell time, the greater the number of target ions detected. In simultaneous multi-component analysis, dwell time may be shortened for each target component.

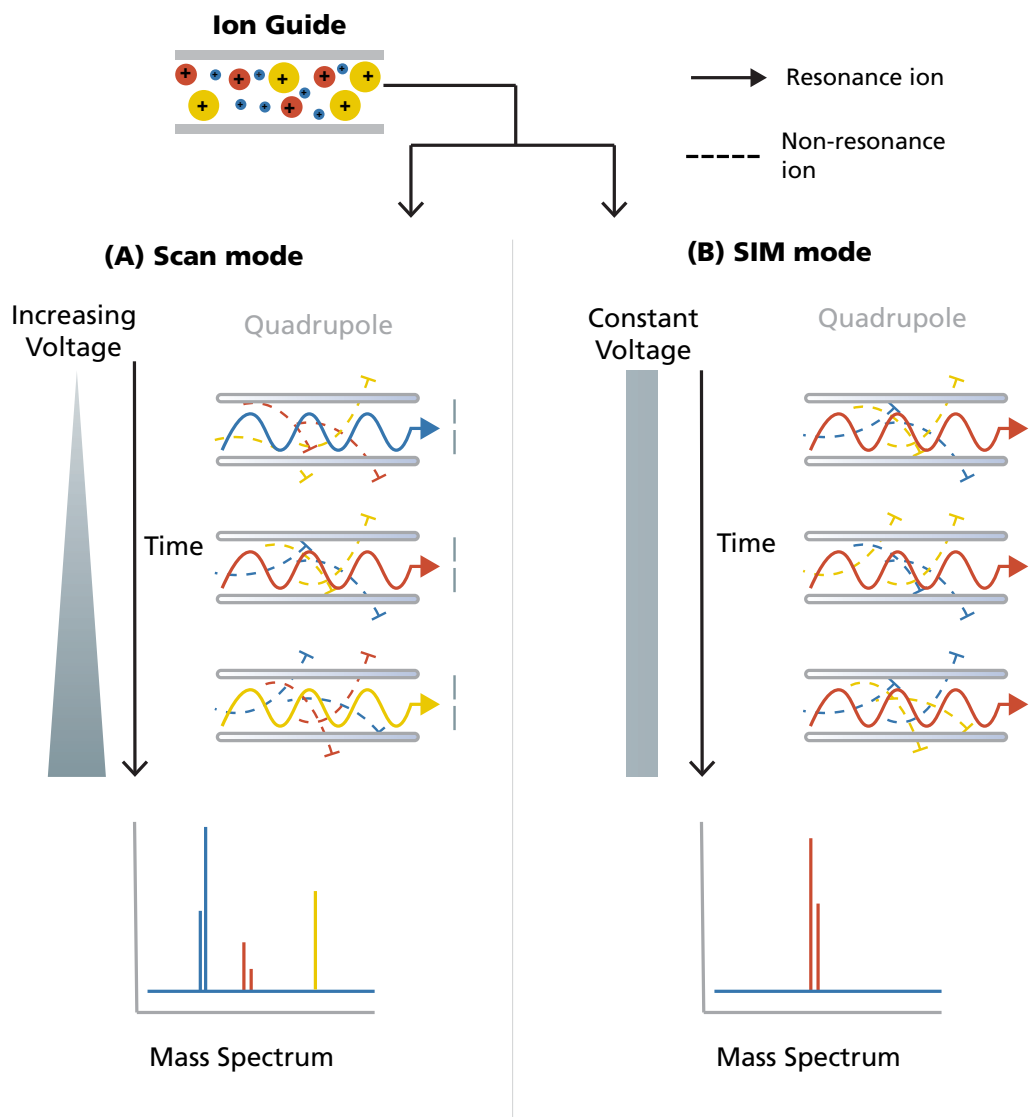

Figure 16. Schematic of the (A) scan mode and (B) SIM mode in Quadrupole MS.

Since the separating principle of the quadrupole MS systems is straightforward, they are comparatively easier to operate and maintain. Also, the quadrupole is compact in design, robust and relatively inexpensive. Consequently, they are widely adopted as a general-purpose analytical instrument. Furthermore, unlike other MS which require high vacuum levels, quadrupole MS can adequately function at lower vacuum levels ( $\approx 10^{-2}$  to  $10^{-3}$  Pa). Even if they are interfaced with a GC or LC unit, the drop in vacuum level caused by the interface has minimal effect on the mass separation performance, making it the best suited for interfacing with chromatographic techniques.

Quadrupole MS demonstrates good scan speed and sensitivity. With a maximum scan speed of 15,000 amu/second, it is capable of measuring at higher scan speeds than the magnetic sector MS. Its mass range can reach up to 2,000  $m/z$  which enables the qualitative analysis in a practical range of molecular masses. In addition, it allows high-speed polarity switching, which facilitates simultaneous monitoring of multiple selected ions of different polarity. With the use of the

SIM mode in a quadrupole MS, it can deliver a high-sensitivity quantitative analysis of a large number of target compounds, making it a widely recognized system among MS.

### Time-of-Flight (TOF) MS

Unlike magnetic sector and quadrupole MS, Time-of-Flight (TOF) MS is a pulsed and non-scanning MS. It has a simple construction, consisting of an accelerator, a field-free region, a reflectron and detector inside a high vacuum chamber called a flight tube (Figure 17).

TOF MS separates and detects ions of different  $m/z$  by measuring the time taken for the ions to travel through a field-free region. First, ions generated in an ionization unit are accumulated and introduced in pulses to a flight tube. These ions are accelerated by applying a high acceleration voltage between the electrodes. The corresponding kinetic energy is obtained as described in Equation 9. Given a constant acceleration voltage as well as kinetic energy, each ion flies at its unique velocity inside the flight tube to reach the ion detector, which is higher for ions with smaller masses and lower for ions with larger masses.

# LCMS-2020

Liquid Chromatograph Mass Spectrometer



## Seeing is Believing.

### *UFscanning*

15,000 u/sec high-speed scanning

### *UFswitching*

15 milliseconds high-speed polarity ionization switching time

### *UFsensitivity*

High-speed analysis with high sensitivity

## UFscanning & UFswitching

### UFLC/MS Measurement

UFscanning and UFswitching are critical for ultra-fast analysis.

In ultra-fast analysis where multicomponent may elute within 1 minute, ultra-fast (MS measurement) detection is also required. The UFswitching and UFscanning functions are what make possible such ultra-fast MS measurement.

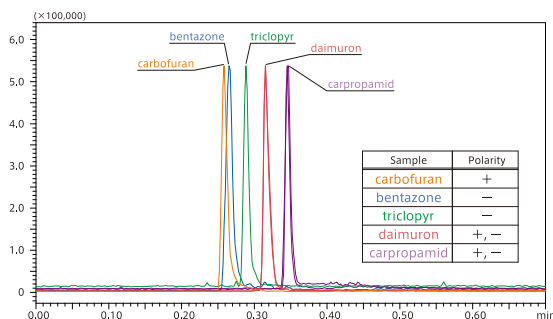
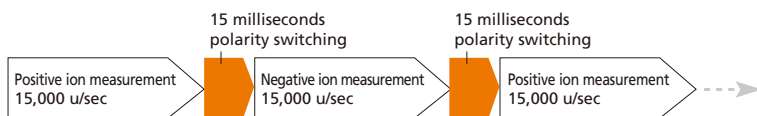

## UFsensitivity

### Ultra-fast analysis with excellent sensitivity

Newly developed ion optical system and new Qarray® optics provide excellent sensitivity, repeatability and linearity, even in ultra-fast analysis.

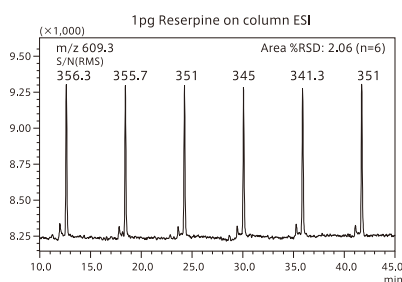

Calibration curve: 0.1, 1, 10, 100, 1000 pg

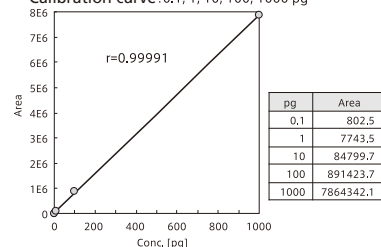

## Hardware features that powerfully support 3 types of UF functionality

### Toughness against dirty samples

In order to check toughness of LCMS-2020 against dirty samples, plasma samples simply precipitated with only acetonitrile were injected 2,500 times over 10 days (1L volume per injection). Excellence reproducibility of peak area was demonstrated and its RSD was 2.26%.

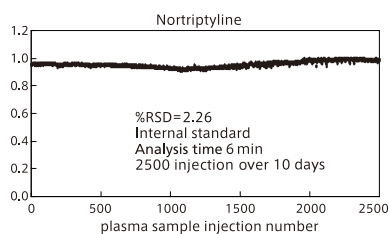

### Easy Maintenance

The DL capillary (desolvation line), which transfers the sample into the vacuum chamber from the ion source, can be installed and removed without breaking the vacuum, greatly speeding maintenance operations.



Company names, product/service names and logos used in this publication are trademarks and trade names of Shimadzu Corporation and its affiliates, whether or not they are used with trademark symbol "TM" or "®". Third-party trademarks and trade names may be used in this publication to refer to either the entities or their products/services. Shimadzu disclaims any proprietary interest in trademarks and trade names other than its own.

For Research Use Only. Not for use in diagnostic procedures. The contents of this publication are provided to you "as is" without warranty of any kind, and are subject to change without notice. Shimadzu does not assume any responsibility or liability for any damage, whether direct or indirect, relating to the use of this publication.

SHIMADZU Corporation

[www.shimadzu.com/an/](http://www.shimadzu.com/an/)

© Shimadzu Corporation, 2012

Printed in Japan 3295-11103-30ANS

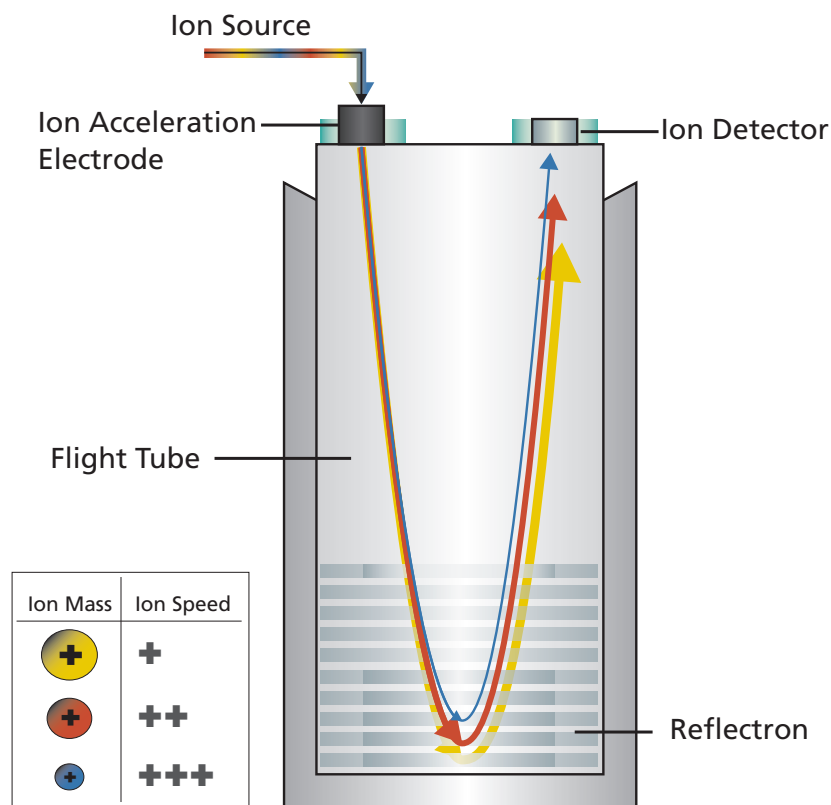

Figure 17. Schematic of a TOF MS.

Equation 9:

$$KE_{\text{ion}} = \frac{1}{2} mv^2 = zeV$$

Equation 10:

$$T = \frac{\text{distance}}{\text{velocity}} = \sqrt{\frac{m}{z}} \times \frac{L}{\sqrt{2eV}}$$

T: Time of flight

m: mass of the ion

v: velocity of the ion

z: charge of the ion

e: elementary charge

V: acceleration voltage applied to ions

L: flight distance in TOF

As shown in Equation 10, Time of flight (T) is proportional to the square root of  $m/z$ , i.e. for a fixed flight distance (L), ions with smaller  $m/z$  reach the detector sooner than those with larger  $m/z$ . Therefore, by keeping all other parameters constant, the time of flight (T) can be converted directly to  $m/z$ , which is how a mass spectrum is generated in a TOF MS. Since there is no limit to the time of flight in TOF MS, it can theoretically measure an unlimited mass range.

Due to its operating principle, TOF MS systems do not introduce ions into the analyzer until after the previous group has reached the detector. Therefore, it has good compatibility with ionization methods that ionize molecules in pulses, such as laser



ionization. This analytical technique has been extremely useful for proteomics using MALDI-TOF MS systems, where proteins are identified by comparing measurements of fragmented peptides with a database. With advancements that minimize the differences in the kinetic energy of ions, such as the use of reflectron and pulsed extraction methods, TOF MS systems are currently being utilized for high-resolution MS.

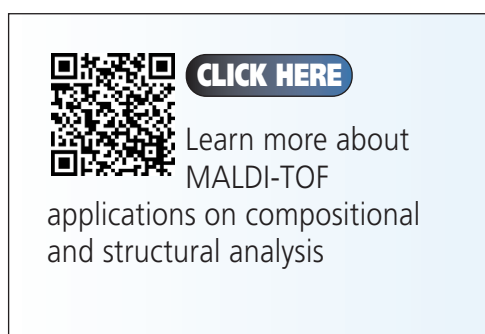

### Ion Trap (IT) MS

IT MS is based on an ion trapping mechanism and pulsed MS. There are several variations of IT MS, for example the 2D linear quadrupole IT MS and the 3D ring IT MS and the components and system configurations may vary slightly. These IT MS employ the same principle as the quadrupole MS and the motion of ions within the mass analyzer follows the Mathieu Equation (Figure 15). In this section, the 2D linear quadrupole IT MS are described in greater detail. It generally consists of a donut-shaped ring electrode sandwiched between two end-cap electrodes (Figure 18). An ionization unit is located at the entrance and a detector at the exit. Just like a quadrupole system, the internal surface of electrodes is hyperboloidal, which

can be thought of as the entrance and exit of a quadrupole connected in a ring shape. Normally, the IT MS is used without applying the direct current voltage ( $U$ ) to the electrodes, which corresponds to movement and operation along the horizontal axis.

To measure a spectrum, end-cap electrodes are first grounded, then a low high-frequency voltage is applied to the ring electrode. The ions are introduced into the IT MS in a pulse mode, where they are all temporarily trapped inside the electrode. This state, where the ions with varying mass are experiencing stable oscillations, is indicated in Figure 18A. Subsequently, to detect a specific ion, the high-frequency voltage is gradually increased (Figure 15, straight scan line 2), while keeping the direct current ( $U$ ) to zero. As the voltage increases (Figure 15), the oscillation of the blue ion becomes unstable at point B in the Mathieu diagram and the red ion becomes unstable at point C, at which time these ions are discharged via the hole in the end-cap electrode (Figure 18B). Quadrupole MS systems separate and detect masses by letting oscillating ions pass through the quadrupole to reach a detector, whereas ion trap MS systems separate and detect masses by discharging ions with unstable oscillations from the system.

As the name implies, ion trap MS systems trap the generated ions before separating them by mass. Consequently, they cannot perform selected ion monitoring (SIM) transitions and measurements for transmission type MS. Furthermore, they operate by pulsed mode and only a limited

## (A) Stable ion oscillations

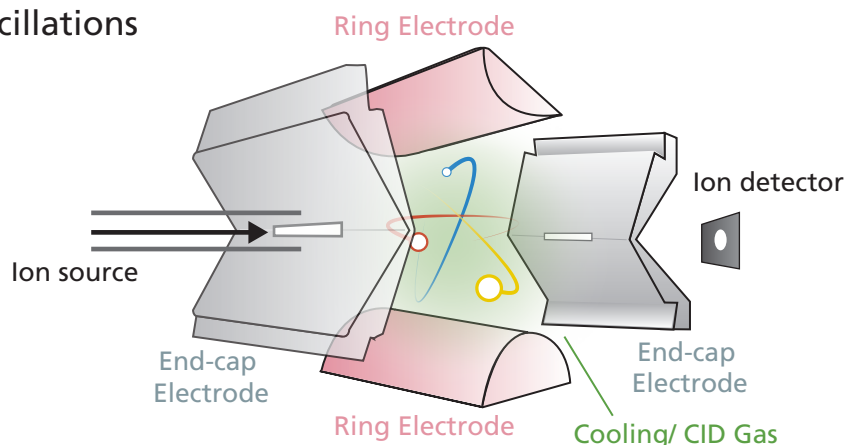

## (B) Discharging of ions with unstable oscillations

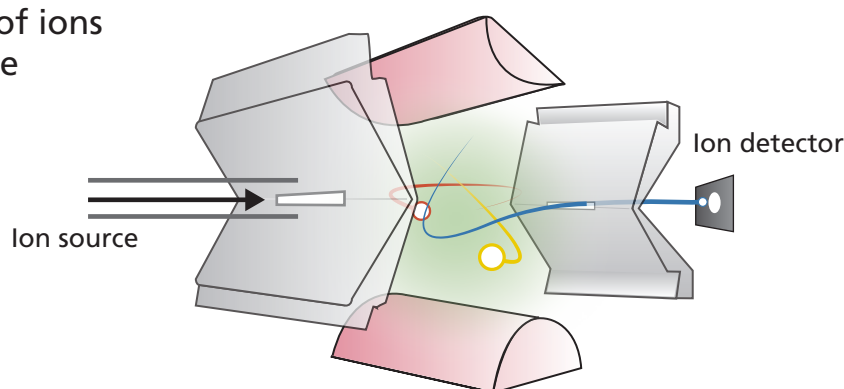

Figure 18. Diagram of an IT MS.

quantity of ions can be trapped, resulting in a narrower dynamic range than quadrupole MS systems. However, all trapped ions are detected in the IT MS, this provides higher sensitivity in scanning analysis than quadrupole models. In addition, it enables the trapping of a specific ion, fragmenting it and then trapping a specific product ion for further fragmentation, and so forth. Therefore, IT MS is considered a mass spectrometer specialized for elucidating the fragmentation pathway for structural determination of a target molecule.

In addition to the two kinds of IT MS, there are other similar trapping type of MS such as the Fourier Transform Ion Cyclotron Resonance (FT-ICR) and Orbitrap. They adopt

similar mechanism and principles. In the FT-ICR setup, the use of both the electric and magnetic field generates the stable oscillation and motion of the ions. To detect the ions, the selected ions are accelerated such that its radius of oscillating motion increases, the oscillation becomes unstable and eventually the ion gets removed. By determining the cyclotron frequency, it can be Fourier transformed and the ion mass is deduced. For Orbitrap MS systems, it only requires the use of electric field to trap and separate the ions. These MS systems demonstrate excellent mass resolution and mass accuracy.

## Comparison of mass analyzers

It is important to note that no single mass analyzer is excellent for all analyses. Therefore, it is important to understand the different principles, features and characteristics of these mass analyzers and choose the one suitable for your needs. Some of the key advantages and limitations

of these single mass analyzers are listed in Table 4.

Mass spectrometers are now used for an extremely diverse range of applications, each with its own characteristics. Therefore, it is not easy to decide in a simple manner which type of MS is optimal. In terms of cost and ease-of-operation, quadrupole mass

**Table 4.** Advantages and limitations of the various mass analyzers.

Mass Analyzer	Description	Advantages	Limitations
Magnetic Sector	Scanning Continuous	<ul style="list-style-type: none"> <li>• High resolution</li> <li>• High dynamic range</li> <li>• High reproducibility</li> <li>• High sensitivity</li> </ul>	<ul style="list-style-type: none"> <li>• Expensive and bulky</li> <li>• Slow scan speed</li> <li>• High vacuum required</li> <li>• Difficult to couple with pulsed ionization techniques and LC</li> </ul>
Quadrupole	Scanning Mass Filter Continuous	<ul style="list-style-type: none"> <li>• Compact and simple</li> <li>• Relatively cheap</li> <li>• Good selectivity (SIM)</li> <li>• Moderate vacuum required → well suited for coupling to LC</li> </ul>	<ul style="list-style-type: none"> <li>• Limited mass range</li> <li>• Low resolution</li> <li>• Little qualitative information</li> </ul>
Time-of-Flight	Non-scanning Pulsed	<ul style="list-style-type: none"> <li>• High sensitivity and ion transmission</li> <li>• High resolution</li> <li>• Excellent mass range</li> <li>• Fast scan speed</li> </ul>	<ul style="list-style-type: none"> <li>• Requires pulsed introduction to MS</li> <li>• Requires fast data acquisition</li> </ul>
Ion Trap	Trap Pulsed	<ul style="list-style-type: none"> <li>• Small and relatively cheap</li> <li>• High sensitivity</li> <li>• Good resolution</li> <li>• Compact</li> </ul>	<ul style="list-style-type: none"> <li>• Limited dynamic range</li> <li>• Limited ion trap volume</li> <li>• Limited resolution</li> <li>• Requires pulse introduction to MS</li> </ul>



**CLICK HERE**

### Investigation of Synthetic Compounds in Drug Discovery by Nexera-i and LCMS-2020.

Read more about the analysis of pharmaceutical substances in a workflow that is typically used for pharmaceutical synthesis confirmation analysis. The use of Nexera-i integrated UHPLC system with high-scan-speed LCMS-2020 offers rapid and comprehensive qualitative and quantitative analysis.

#### Sample Name: Trimethoprim

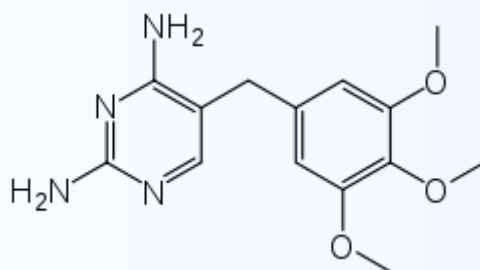

log P : 0.91  
pK<sub>a</sub> : 7.12

MS Chromatogram

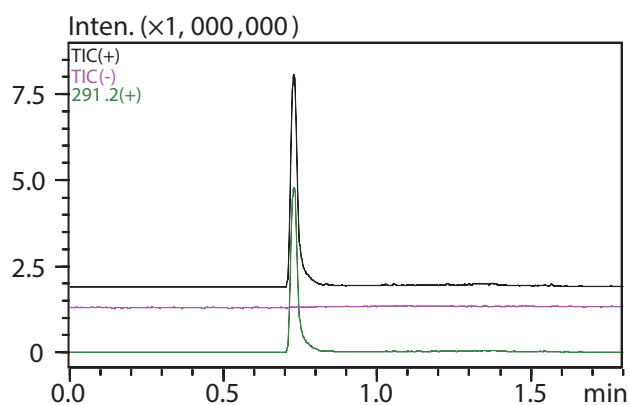

MS Spectrum

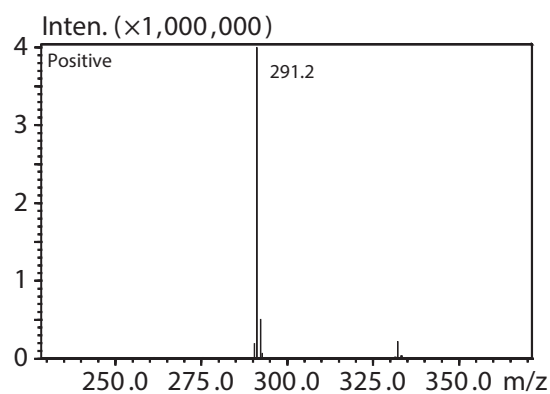

analyzers have been increasing in market share for LCMS applications. Likewise, ion trap and TOF MS systems offer performance not obtainable from quadrupole models, so their usage and popularity is also continuing to increase. This means the MS system must be selected based on objectives, be

it sensitivity, peak resolution, or a compact general-purpose system. In summary, it is important to consider and choose a MS system that allows benefiting from the advantages offered by each ionization method and mass separation technique.

# Chapter 4

## Introduction to tandem MS systems

Chapter 4 introduces the core concept and key features of a MS/MS system. It includes the basic instrumentation, the collision-induced dissociation and the various scan modes in MS/MS. Tandem/Hybrid MS systems (e.g. Triple Quadrupole MS, Q-TOF, and IT-TOF) is a versatile and powerful instrument used in many applications. To gain a better understanding and to find the most suitable system for your application, the resolution, sensitivity, capabilities and strengths of these MS/MS are compared.



## Core principles

MS is a very useful and powerful tool in quantitative and qualitative analysis. Furthermore, it can identify analytes based on  $m/z$  and provide accurate mass information on elemental composition, isotopic analysis and structural information. However, there are limitations of a single mass spectrometer. A single MS may not provide reliable quantitative and qualitative information in cases where resolution is insufficient (hard to separate) for both chromatography and  $m/z$  (e.g. isomers). This is particularly the case where the sample matrix is complex and the target analytes are in trace concentrations. Therefore, a technique that provides a higher selectivity, specificity and sensitivity and gives additional unique mass and structural information of the target analytes is required.

A MS/MS system, also known as a tandem/hybrid<sup>6</sup> MS (denoted MS/MS), consists of two mass analyzers connected in series with a collision or fragmentation cell in between. Ions are separated in the first mass analyzer (MS1), enter the collision cell and undergo fragmentation, resulting in generation of ions called product ions which are separated in the second mass analyzer (MS2) and detected. MS/MS serves as a solution for the challenges faced by a single MS analysis. Since its introduction, MS/MS has been a versatile and powerful instrument for many applications such as (1) drug discovery and development, (2) structural analysis of polysaccharides and

proteins and (3) metabolomics identification and quantitation research. Notably, the use of MS/MS provides detailed mass information and allows the reduction of matrix interferences and background giving superior selectivity and sensitivity.

The basic components in a MS/MS system are illustrated in Figure 19. Like LCMS, MS/MS system can be coupled to a LC or GC for chromatographic separation prior to MS analysis. The main difference between a LCMS and a LC-MS/MS is the addition of a collision cell and a MS2. The single mass analyzers described earlier (e.g. quadrupole, TOF, ion trap or magnetic sector MS) can be integrated into a MS/MS system.

<sup>6</sup>Tandem MS refers to MS/MS systems that use the same mass analyzers (e.g. triple Quadrupole MS/MS) while hybrid MS refers to MS/MS systems with different MS systems (e.g. Quadrupole-TOF MS).

## i-Series



Awarded with  
The Analytical Scientist  
Innovation Award

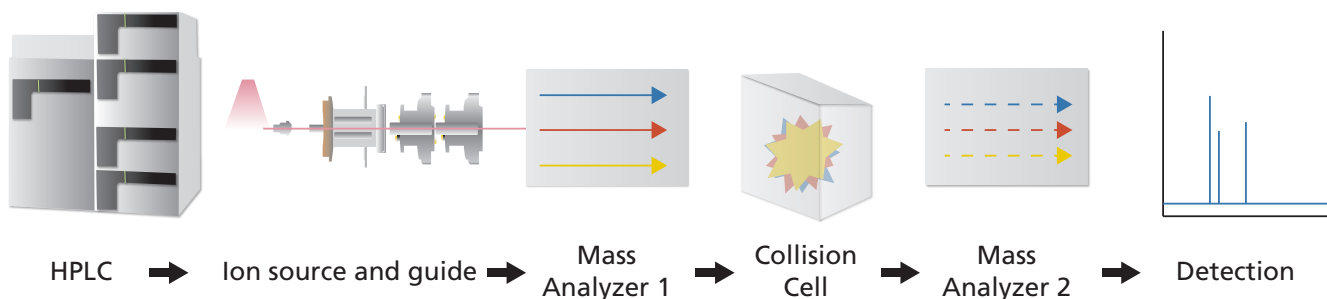

Figure 19. Basic instrumentation of a LC-MS/MS.

Collision-induced dissociation (CID) is the preferred method of fragmentation in the collision cell. Fragmentation of the precursor ions occurs and this provides unique MS data of the fragment ions. Figure 20 illustrates the processes and fragmentations that occurs in the collision cell.

The precursor ions of  $m/z$  selected by MS1 enter the collision cell filled with chemically inert gas (e.g. He, Ar, Xe and N<sub>2</sub>) and collisions between the precursor ions and inert gas are induced by applying an oscillatory field (giving a 'shake'). Collisions cause conversion of kinetic energy into molecular excitation (internal energy) that cause chemical bond breakage to generate product ions. The degree of fragmentation and product ion species depend on the

energy supplied because some bonds require higher activation energy than others for breakage. As shown in Figure 21, with a CID collision energy of 0 volts, the molecular ion of Osteltamivir ( $m/z = 313$ ) is of highest abundance with no product ions. As collision energy increases, the abundance of the molecular ion decreases and fragmentation occurs to generate a variety of product ions. At even higher collision energies (e.g. >50 V), the degree of fragmentation is more extensive resulting in the mass spectrum showing no molecular ion and higher abundances of product ions of lower  $m/z$ . Besides CID, there are other less common alternatives to induce fragmentation such as electron capture/transfer dissociation, surface-induced dissociation and photodissociation.

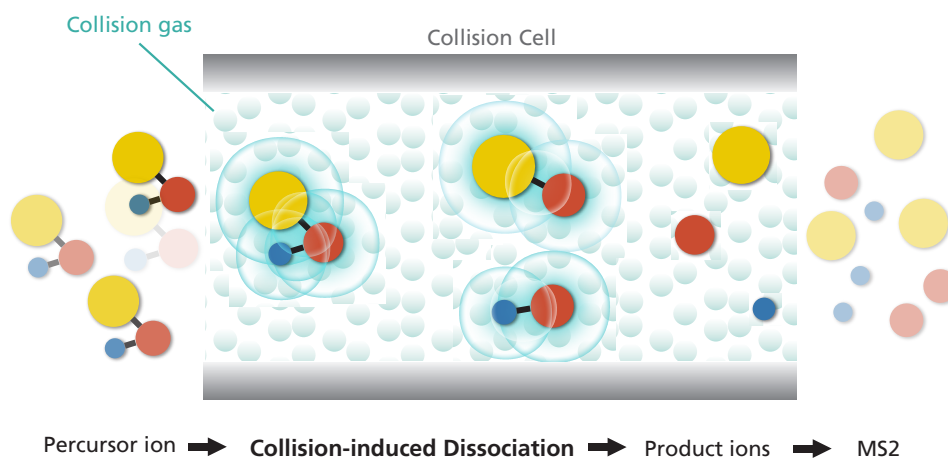

Figure 20. Illustration of CID in the collision cell of MS/MS systems.

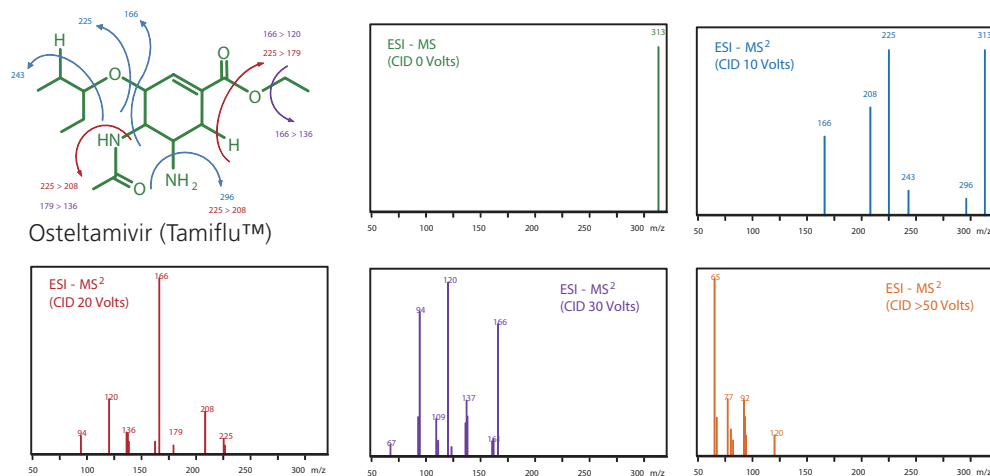

Figure 21. CID of Osteltamivir (Tamiflu) at various collision energies (0, 10, 20, 30, >50 V).

Figure 16 describes the scan and selected ion monitoring (SIM) modes of a quadrupole MS. Likewise in MS/MS, the MS1 and MS2 can either acquire the scan or SIM (fixed) mode. The different arrangements allow the system to operate at various scan and monitoring modes (Figure 22). It is important to note that the actual scan and monitoring modes available in MS/MS systems depends on the mass analyzers (MS1 and MS2) used. Some of these scan modes (e.g. precursor ion and neutral ion scan) may not be available in time-based<sup>7</sup> MS (e.g. ion trap and FT-ICR).

For a long time, Selected Reaction Monitoring (SRM) used to be the term

historically preferred by IUPAC, while instrument vendors including Shimadzu preferred the alternative term, Multiple Reaction Monitoring (MRM). Now IUPAC recommends that the term SRM be used to describe the technique applied to a single target and MRM for plurality of SRM. In this document hereafter, the technique is referred to as MRM regardless of the number of precursor/product pairs monitored simultaneously.

Prior to performing MRM, product ion scan is usually conducted to determine the product ion of highest abundance. In conclusion, MS/MS can not only remove noise and interference but also selectively target particular ions for quantitation to deliver a higher specificity and sensitivity analysis.

<sup>7</sup>Time-based MS refers to ion trap and FT-ICR MS, where ions are separated temporally and gets detected sequentially at a fixed point. On the other hand, space-based MS separates ions spatially based on their deviation in terms of path radius or velocity. Examples of space-based MS are magnetic sector, quadrupole and TOF MS.



**CLICK HERE**

Structure elucidation of pharmaceuticals using ultrafast triple quadrupole MS.



**CLICK HERE**

Find out about how precursor ion scan, neutral loss scan and MRM is used in Simultaneous Analysis of Amino Acids and Acylcarnitines in Dried Blood Spot with LCMS-8040



**(A) Product Ion Scan:**

MS1 is fixed at selected  $m/z$  while MS2 operates at scan mode. This scan acquires all the product ions from the fragmentation of a selected precursor ion. The intensity and  $m/z$  of all product ions are captured and displayed in the mass spectrum.

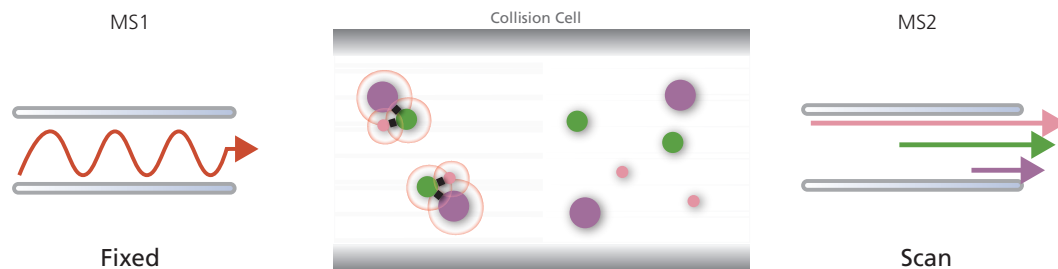
**(B) Precursor Ion Scan:**

MS1 operates at scan mode while MS2 selects the product ion of a particular  $m/z$  formed by CID in the collision cell. This mode is especially useful for determining the precursor ions that produce fragment ions of a particular  $m/z$ .

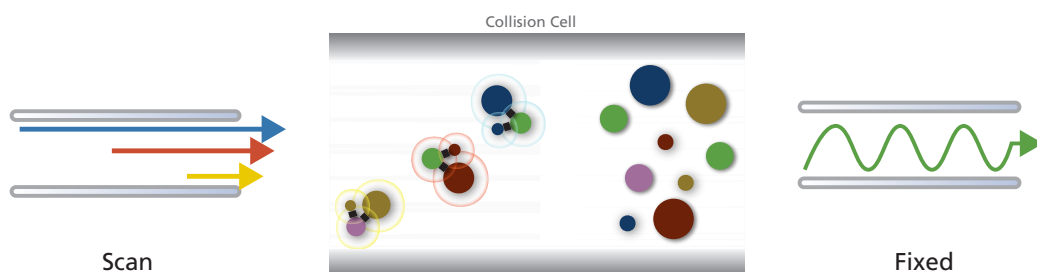
**(C) Neutral Loss Scan:**

MS1 and MS2 operate at scan mode while keeping a specific  $m/z$  difference. This scan can determine the precursor ions that lose a specific neutral molecule (e.g. hydroxyl group and phosphate group) during fragmentation.

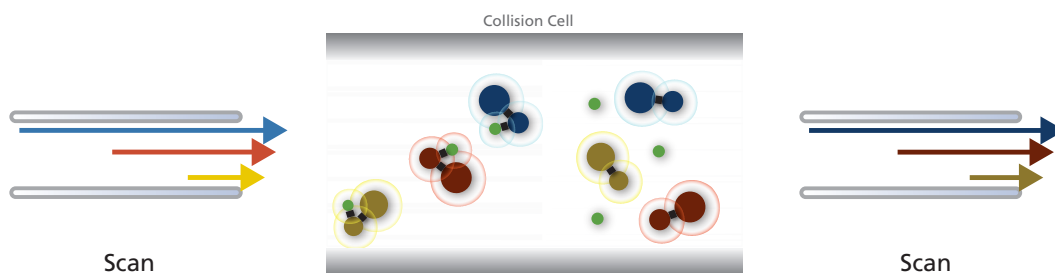
**(D) Selected Reaction Monitoring (SRM):**

The transition of a selected precursor ion to a selected product ion is monitored where MS1 and MS2 are fixed at the specific  $m/z$ .

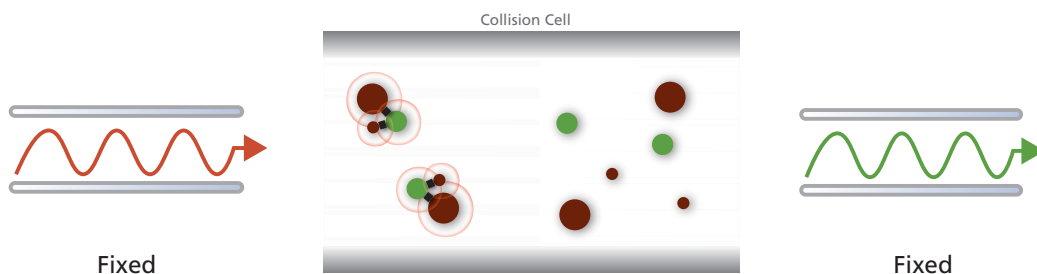

Figure 22. Types of scan and monitoring modes in MS/MS systems.

## Types of MS/MS systems and their key characteristics

With the combination of two mass analyzers in MS/MS systems, several tandem and hybrid configurations consisting of quadrupole, magnetic sector, TOF and/or ion trap MS are obtained (Table 5). There are no changes to the separating principles of these mass analyzers in a MS/MS system. The following sections elaborate on the key characteristics of these MS/MS systems (i.e.

TQ, Q-TOF, IT-TOF and multistage MS) and discuss in detail its applications, strengths and limitations.

Other than these MS/MS systems, there are also other tandem/hybrid MS that utilizes more than 2 mass analyzers. However, this configuration is not commonly used due to the higher cost and complexity of the equipment.

Table 5. Various tandem/hybrid MS/MS systems.

<p><b>Tandem MS</b></p>	<p>Triple Quadrupole (TQ)</p> <p>2 Dual-focusing MS (combination of magnetic &amp; electric fields)</p>
<p><b>Hybrid MS</b></p>	<p>Quadrupole Time-of-Flight (Q-TOF)</p> <p>Ion trap Time-of-Flight (IT-TOF)</p> <p>Quadrupole Ion Trap (Q-IT)</p> <p>Quadrupole Ion-Cyclotron-Resonance (Q-ICR)</p> <p>Ion trap Ion-Cyclotron-Resonance (IT-ICR)</p> <p>Ion trap Orbitrap (IT-Orbitrap)</p> <p>2 Time-of-Flight (TOF-TOF)</p> <p>Multistage MS (MS<sup>n</sup>)</p>

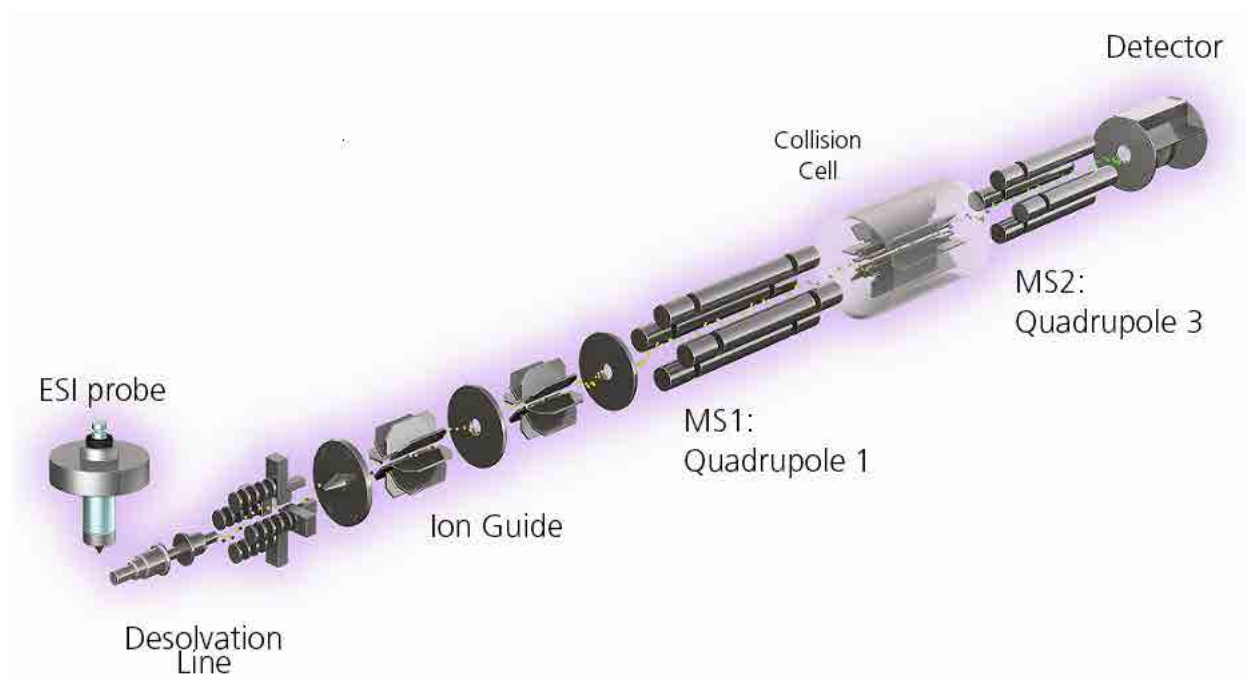

Table 23. Instrumentation of Triple Quadrupole (TQ) MS.

### Triple Quadrupole (TQ) MS

The simplest and most common MS/MS system is the TQMS. It consists of three quadrupoles arranged in series with the first and third quadrupole acting as MS1 and MS2 respectively and the CID taking place in the second quadrupole (Figure 23). With the use of precursor ion scan, neutral loss scan and MRM, it can achieve superior selectivity, specificity and sensitivity with minimal background. As a result, TQ MS is an excellent instrument for quantitative analysis and is commonly employed for routine targeted analyses.

On the contrary, TQ MS falter in terms of mass accuracy and resolution as compared to other types of MS/MS. It is not commonly employed for untargeted analyses. Another reason is that prior knowledge of the compound (e.g. molecular ion mass) is required to utilize the high sensitivity MRM modes in TQ MS. In this case, other MS/MS systems such as Q-TOF and IT-TOF are used.

### Quadrupole Time-of-Flight (Q-TOF) MS

By switching the last quadrupole mass analyzer in a TQ MS to a TOF mass analyzer, we will get the Q-TOF hybrid MS (Figure 24). With the inclusion of a TOF, this hybrid system provides excellent dynamic range, high mass resolution and mass accuracy. In addition, it can perform good quality quantitative analysis. With the full scan and full ion transmission capability in Q-TOF MS, it captures all the ions in a single run and allows the reinvestigation of data for new and unknown compounds without the need for reacquiring. With these properties, it is commonly used for high resolution accurate mass analysis such as in the identification of unknown molecules for proteomics and metabolomics research.

Liquid Chromatograph Mass Spectrometer

# LCMS-8060

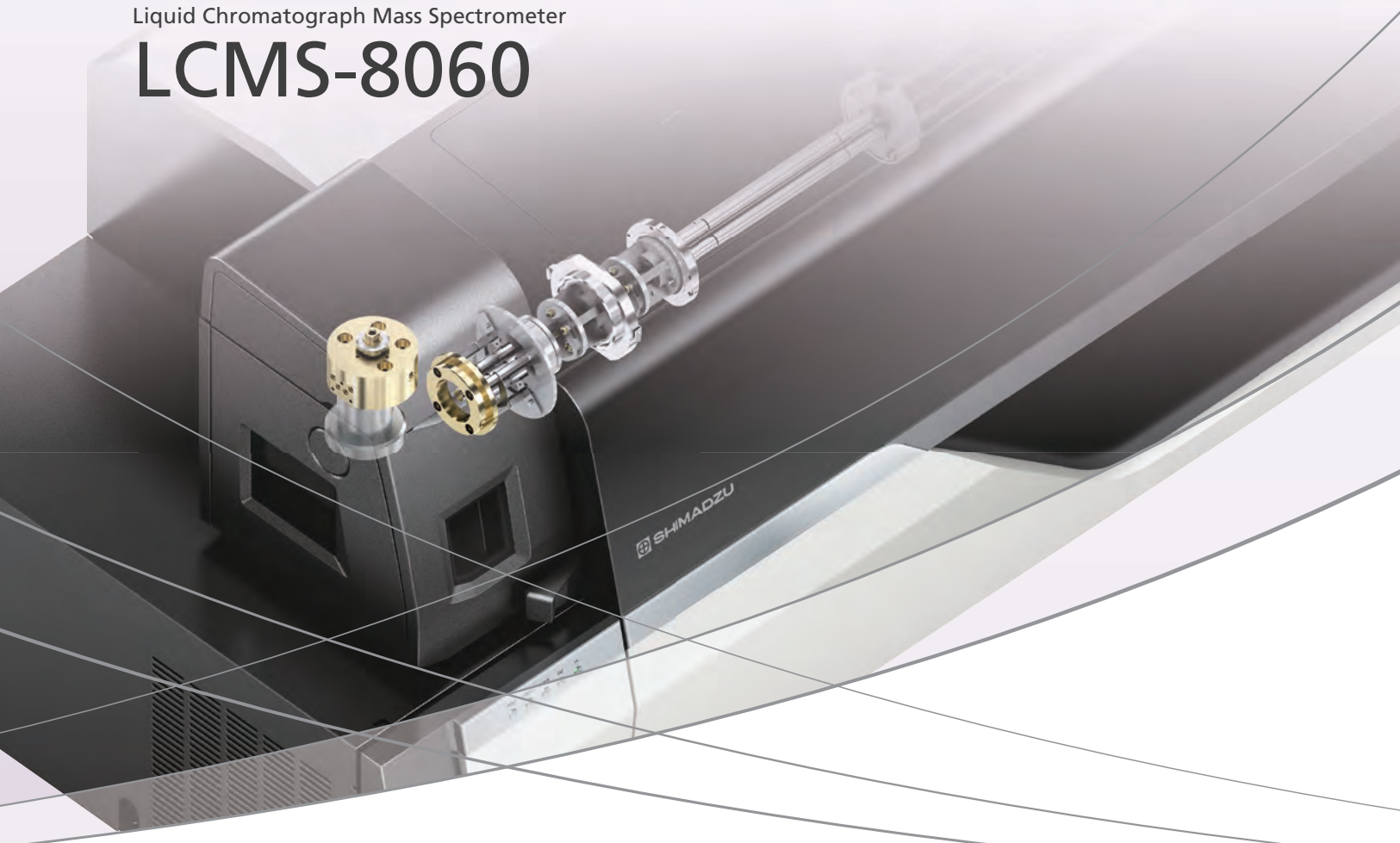

## CHANGES **EVERYTHING**

The LCMS-8060 is the latest in Shimadzu's Ultra-Fast Mass Spectrometry product line, designed to deliver you the highest sensitivity and fastest analysis speed of any LCMS on the market today.

Sensitivity

### Highest Sensitivity

A newly developed UF-Qarray boosts ion intensity but suppresses noise. By improving the ion sampling device, the ion guide, and vacuum efficiency, Shimadzu has achieved an unprecedented sensitivity in LCMS.

Speed

### Fastest Speed

Shimadzu's proprietary technologies allow acquisition of up to 555 MRM channels per second, ultra-fast polarity switching, and ultra-fast scanning, all with high data quality.

UFscanning: Max. 30,000 u/sec

UFswitching: 5 msec

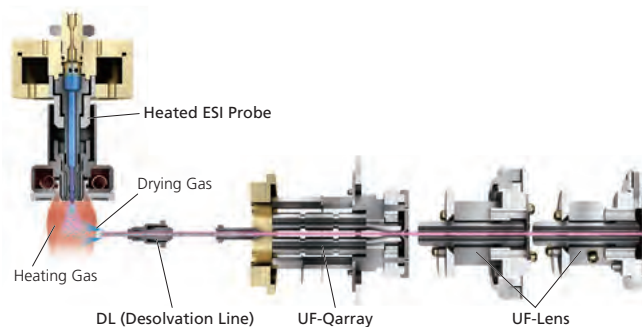

Solutions

### Fusion of sensitivity and speed

Don't miss an exciting performance results in **next page!!**



# High-Sensitivity Quantitation of Catecholamines in Plasma

Catecholamines in plasma, namely norepinephrine (NE), epinephrine (EP) and dopamine (DA), are routinely measured in the research of such diseases as hypertension or neuroblastoma. Since plasma samples contain endogenous catecholamines, it is difficult to evaluate the LLOQ in plasma matrix. Here we used deuterated catecholamine compounds as standards to estimate the LLOQ in plasma matrix, rather than as internal standards for quantitation.

A neat standard curve was prepared by serial dilution in HPLC solvent, whereas a matrix-matched standard curve was prepared by dilution with pooled plasma sample treated with SPE. The table on the right summarizes the quantitation results, which convincingly demonstrate the capability of LCMS-8060 to detect catecholamines at ultra-high sensitivity without matrix interference.

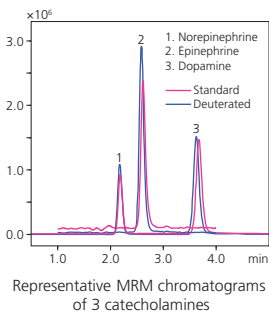

Quantitative range of neat and matrix-matched calibration curves

Compound name	Neat standard curve		Matrix-matched	
	Range (pg/mL)	Linearity (r <sup>2</sup> )	Range (pg/mL)	Linearity (r <sup>2</sup> )
Norepinephrine-d6 (158.1 > 111.1)	2.5 – 2000	0.9999	2.5 – 2000	0.9997
Epinephrine-d6 (190.1 > 172.1)	10 – 2000	0.9999	10 – 2000	0.9994
Dopamine-d4 (158.1 > 95.1)	5 – 2000	0.9999	10 – 2000	0.9995

In the actual quantitation assay, deuterated catecholamines are spiked as internal standard at 500 pg/mL in plasma and analyzed by LCMS-8060. The figures on the right show the MRM chromatograms of spiked and endogenous catecholamines in plasma.

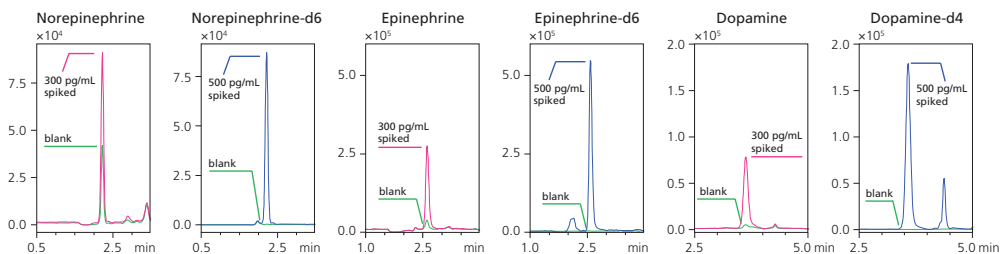

Detection of Norepinephrine, Epinephrine and Dopamine and their deuterated internal standards in plasma.

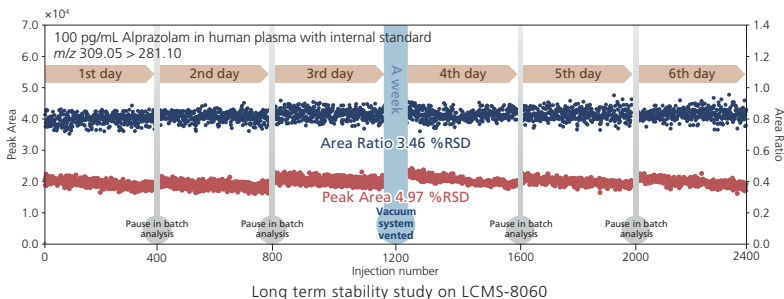

Long term stability study on LCMS-8060

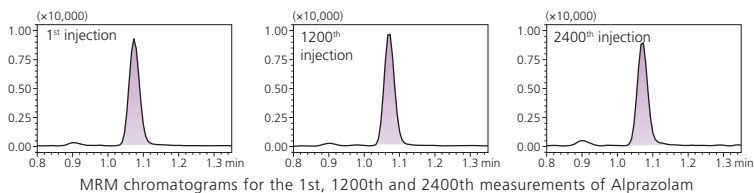

Intraday and interday variations on LCMS-8060

Compound	Intraday Variation (%RSD)						Interday Variation (%RSD)		
	1st day	2nd day	3rd day	4th day	5th day	6th day	Days 1–3	Days 4–6	6 Day Total
Alprazolam	5.04	4.94	5.06	5.38	4.55	4.83	3.19	1.63	2.74
Alprazolam-d5 (ISTD)	5.04	4.68	5.48	5.31	4.26	4.91	2.62	1.89	2.18
Area ratio	3.48	3.11	3.48	3.44	3.71	3.54	1.79	0.26	1.40

## Outstanding Durability

The robustness of the LCMS-8060 and modified ion optics were assessed by injecting 2400 samples of femto-gram levels of alprazolam spiked into protein-precipitated human plasma extracts over a 6 day period (over 400 samples were injected each day). The RSD of peak area response was 5% over this test period; using a deuterated internal standard (alprazolam-d5) the RSD was 3.5%. As part of the robustness test the vacuum system was vented to model a transient power failure with no effect on signal response or baseline noise level.



Shimadzu Corporation  
www.shimadzu.com/an/

For Research Use Only. Not for use in diagnostic procedures.

This publication may contain references to products that are not available in your country. Please contact us to check the availability of these products in your country.

Company names, products/service names and logos used in this publication are trademarks and trade names of Shimadzu Corporation, its subsidiaries or its affiliates, whether or not they are used with trademark symbol "TM" or "®".

Third-party trademarks and trade names may be used in this publication to refer to either the entities or their products/services, whether or not they are used with trademark symbol "TM" or "®".

Shimadzu disclaims any proprietary interest in trademarks and trade names other than its own.

The contents of this publication are provided to you "as is" without warranty of any kind, and are subject to change without notice. Shimadzu does not assume any responsibility or liability for any damage, whether direct or indirect, relating to the use of this publication.

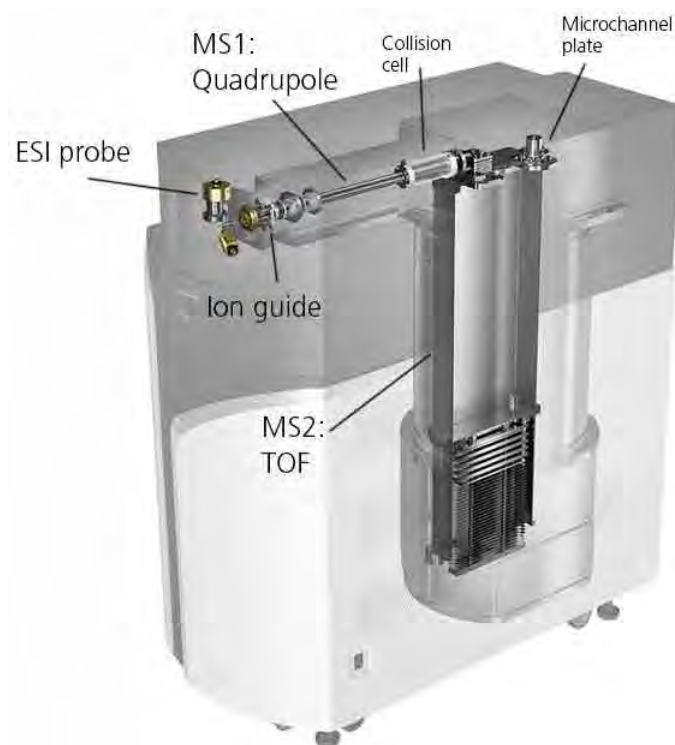

Figure 24. Instrumentation of the Quadrupole Time-of-Flight (Q-TOF) MS.

### Multistage MS ( $MS^n$ )

Multistage MS ( $MS^n$ ) is a technique of performing multiple mass analysis in a single instrument and usually requires a time-based MS. Using ion trap MS as an example, the introduction of ions, selection of precursor ions, fragmentation and analysis of product ions are all performed in a single mass analyzer. Ions are first introduced in the ion trap, the selected  $m/z$  precursor ion is isolated by applying a suitable voltage. The precursor ions oscillate in stable motions in the trap while the rest of the ions are subjected to unstable motions and are ejected from the system. The parameters in the ion trap are then adjusted such that the precursor ions are given vigorous oscillation and collide with pulses of inert gas introduced into the ion trap. The range of product ions are

temporarily trapped and then subjected to either the detection system or to precursor ion isolation for further fragmentation. The entire process can be repeated unlimitedly ( $n$  times) and hence denoted  $MS^n$ . Multistage MS provide unique structural elucidation and qualitative analysis. However, when interpreting mass spectrum from ion trap MS, it is important to note that undesirable artifact ions may be generated due to long trapping conditions and ion-molecule reactions in the ion trap.

### Ion Trap Time-of-Flight (IT-TOF) MS

The IT-TOF MS system provides  $MS^n$  capability with enhanced sensitivity and is coupled with high resolution and high mass accuracy capability of TOF MS. The components in an IT-TOF MS is illustrated in

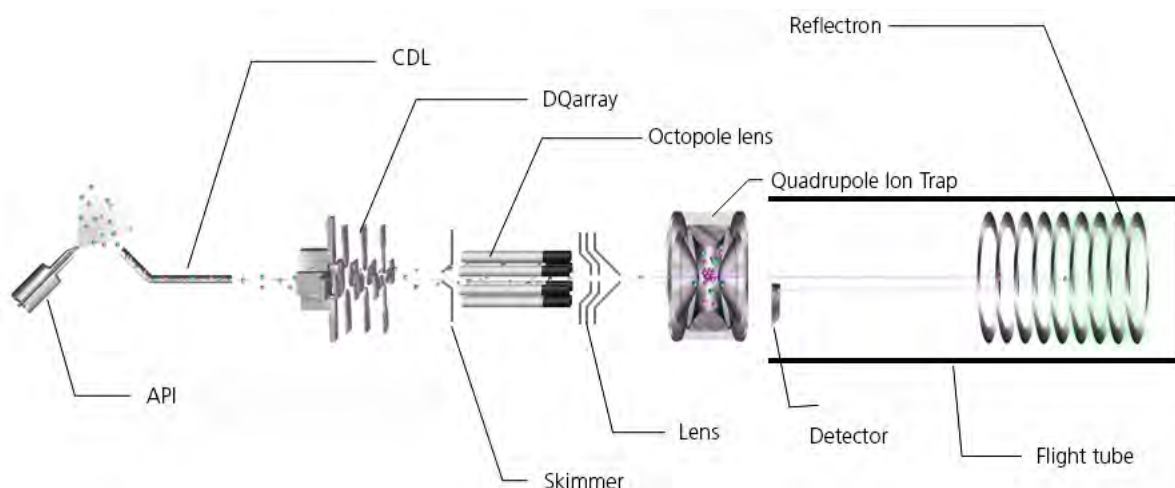
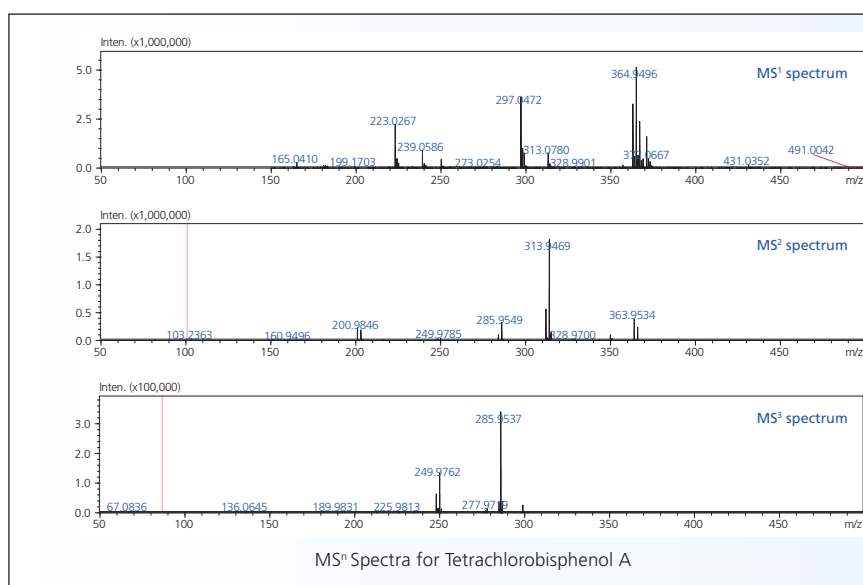

Figure 25. Instrumentation of an Ion Trap Time-of-Flight (IT-TOF) MS.

Figure 25. With the inclusion of the ion trap MS in a IT-TOF MS, there is no need for a collision cell as collisions and fragmentations are possible in the time-based MS itself. The IT MS also double up as a focusing guide to concentrate the ions to the center of the trap before ejecting into the TOF MS. LCMS-IT-TOF enables the identification of compounds using high accuracy  $MS^n$  data and is also frequently applied in impurity analysis, metabolic profiling and biomarker research.

### Comparison of MS/MS systems

In the previous sections, we introduced several MS/MS systems and covered their key features. With all things considered, it is evident that there is no universal MS or MS/MS for all applications and analyses. Each instrument has its own strength and limitations and it is necessary to understand and weigh the pros and cons to determine the most suitable system for your needs.



[CLICK HERE](#)

Development of a spectrum library of endocrine disruptors by LCMS-IT-TOF

Table 6. Comparison of MS/MS systems (TQ MS, Q-TOF MS and IT-TOF MS).

MS/MS Systems	Strengths	Limitations	Applications
TQ MS	<ul style="list-style-type: none"> <li>• Highest sensitivity (MRM)</li> <li>• Wide dynamic range of detection</li> <li>• Lower cost</li> </ul>	<ul style="list-style-type: none"> <li>• Low mass resolution</li> </ul>	<ul style="list-style-type: none"> <li>• Quantitative analysis (MRM)</li> <li>• Targeted analysis</li> </ul>
Q-TOF MS	<ul style="list-style-type: none"> <li>• High mass resolution</li> <li>• Wide mass range</li> <li>• Medium dynamic range of detection</li> <li>• High sensitivity</li> </ul>	<ul style="list-style-type: none"> <li>• Low sensitivity than TQ MS MRM mode</li> </ul>	<ul style="list-style-type: none"> <li>• Qualitative analysis</li> <li>• Structural elucidation</li> <li>• Sequencing</li> </ul>
IT-TOF MS	<ul style="list-style-type: none"> <li>• Multistage MS (MS<sup>n</sup>)</li> <li>• High mass resolution</li> </ul>	<ul style="list-style-type: none"> <li>• Limited in scan modes</li> </ul>	<ul style="list-style-type: none"> <li>• Qualitative analysis</li> <li>• Structural elucidation</li> <li>• Sequencing</li> </ul>

Depending on your objectives, the use of LC, LCMS, LC-MS/MS and even several MS systems may be required. We have earlier provided a comparison table of the various single mass analyzers (Table 4). Now, we compared the performance and limitations of these MS/MS systems (Table 6).

In summary for LCMS single and tandem/hybrid MS systems, TQ MS (MRM mode) ranks first, followed by TOF MS and

then single quadrupole MS (SIM) mode in terms of quantitative analysis performance (e.g. sensitivity, limits of detection, selectivity). While for qualitative analyses, TOF MS is superior based on the accurate mass and high resolution. The ranking is as follows: TOF > Ion Trap > Quadrupole.



# Chapter 5

## Challenges and development of LCMS

In this final chapter, we discussed the needs of industries today and the current challenges of analytical LCMS, with special emphasis on the factors that limit the efficiency and performance of LCMS. We elaborated on how Shimadzu overcome these challenges and develop new technologies to increase the performance and enhance the sensitivity of these analytical instruments. Notably, Shimadzu developed the Ultra-Fast Mass Spectrometry (UFMS) and other key analytical techniques for present and future global needs.

A close-up, low-angle photograph of a Shimadzu LCMS-9030 instrument. The instrument is dark grey or black with a curved top. The Shimadzu logo, a square with a circle and a cross inside, is positioned to the left of the word "SHIMADZU" in a bold, sans-serif font. Below this, the model number "LCMS-9030" is printed in a larger, bold font, followed by "LIQUID CHROMATOGRAPH MASS SPECTROMETER" in a smaller font. On the right side of the instrument, a vertical strip of green indicator lights is visible. The background is a plain, light-colored wall.

 SHIMADZU

**LCMS-9030**

LIQUID CHROMATOGRAPH MASS SPECTROMETER

## Analytical challenges and current limitations of LCMS



Since its introduction, LCMS has proved to deliver high quality data and robust performance. As discussed in earlier chapters, LC and MS technologies have evolved to meet the needs of the industries. With these dynamic developments, the demand for these techniques for both quantitative and qualitative analyses have increased and LCMS has progressively become an essential and routine analytical instrument in many sectors. It has established itself to be a key tool in clinical, pharmaceutical and biopharmaceutical industries for drug discovery and protein analysis. It has also set foot in other applications such as food

safety and development, environmental, energy and chemical.

These industries are also constantly evolving and their demands are growing. Some of the main issues faced by the industries include having complex sample matrices, trace-level analytes, multiple component analysis of targets and unknowns, and complicated and time-consuming sample preparation procedures. Thus, there are needs for more advanced instruments or software that give higher throughput, greater efficiency, lower limits of detection, higher mass accuracy and more user-friendly interfaces.

Besides working to meet these needs, LCMS providers are also striving to improve their analytical products in terms of its throughput, performance and expandability in areas such as:

- a) To increase the efficiency and reproducibility of the ionization process
- b) To create an efficient LCMS interface and ion optics
- c) To reduce unnecessary matrix effects (unwanted suppressions and enhancement)
- d) To minimize sample carryover or crosstalk<sup>8</sup> effects
- e) To increase the efficiency and reproducibility of the fragmentation in collision cell
- f) To enable sufficient chromatographic separation
- g) To provide more options and flexibility in terms of LCMS sample preparation and analysis

These parameters affect the LCMS results. By optimizing these processes, the ion abundance and signal-to-noise ratio will increase and there will be lesser contamination issues. In summary, LCMS manufacturers are looking to achieve these key end-outcomes: high sensitivity, efficiency, reproducibility and durability, and producing a simple and easy-to-use LCMS instrument.

<sup>8</sup>Crosstalk may occur during MRM analysis where the product ions of the previous MRM transition (residual product ions in the collision cell) is erroneously detected as product ions of the next MRM measurement.

 **PITTCON**<sup>2015</sup>  
CONFERENCE & EXPO  
**Editors' Gold Award**

**Nexera UC**  
Unified Chromatography



## Key developments in Shimadzu's LCMS

In this section, we shift our focus to Shimadzu's ongoing efforts to overcome these analytical challenges. New technologies, notably Ultra-Fast Mass Spectrometry (UFMS) and Clinical Laboratory Automation Module (CLAM), are developed to increase efficiency and enhance performance of LCMS.

### Ultra-Fast Mass Spectrometry (UFMS)

Shimadzu has improved the ion optics, collision cell design and data acquisition systems and developed the UFMS. With the use of UFMS, it can obtain unrivalled sensitivity and performance, that arise due to ultra-fast (UF) scanning, UF switching, UF MRM and UF sensitivity.

Firstly, the ion optics system consists of the UF-Qarray and UF-Lens (Figure 26). With the new design, ions are precisely converged and signal losses are minimized. In addition, the efficiency of the ionization process is

improved with the use of a heated ESI probe. Together with the enhanced desolvation line and ion optics system, there is an increase in ion production and transmission, thereby generating a high-intensity and focused ion beam leading to higher sensitivity in LCMS.

The next component of the UFMS consists of the UFsweeper. It is a high-sensitivity and high-speed collision cell that enables ultra-fast ion sweeping. With the new pseudo potential surface (Figure 27), ions entering the collision cell are accelerated and maintain their momentum upon collision. Under these circumstances, the efficiency of the fragmentation or CID is improved. This technology allows quicker and better ion transmission in the collision cell, maintaining signal intensity and dramatically suppressing crosstalk, even when shorter dwell and pause<sup>9</sup> times are used. Furthermore, this results in the possibility of high-speed MRM.

Together with the developments

<sup>9</sup>Measurement conditions must be switched to perform simultaneous measurements of multiple compounds, (multi-component analysis). The time needed for this switching is termed as "pause time". As data cannot be acquired during the pause time, it should be as short as possible.

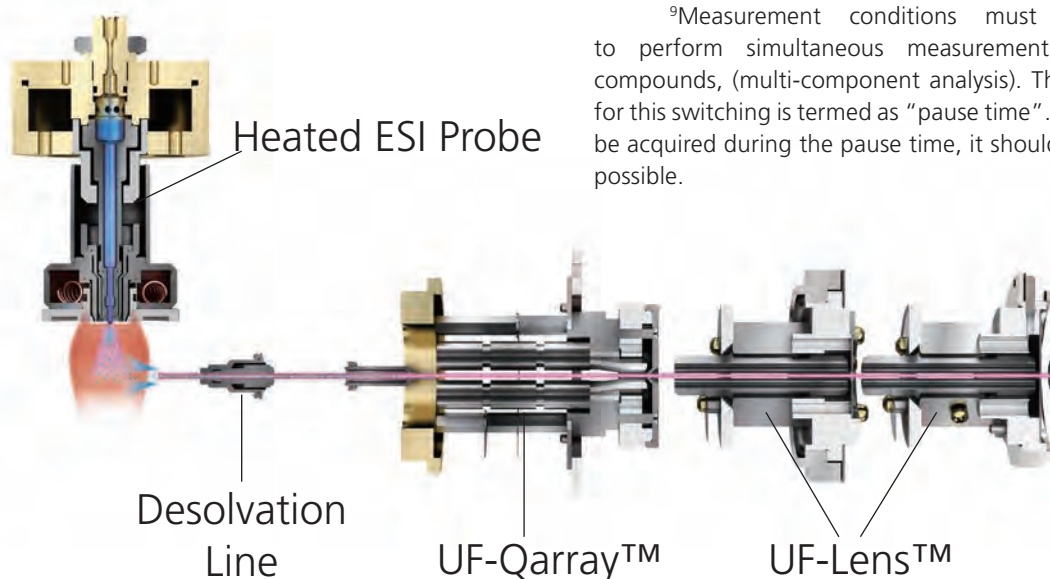

Figure 26. Illustration of the ion source and ion optics (UF-Qarray™ and UF-Lens™) in UFMS.

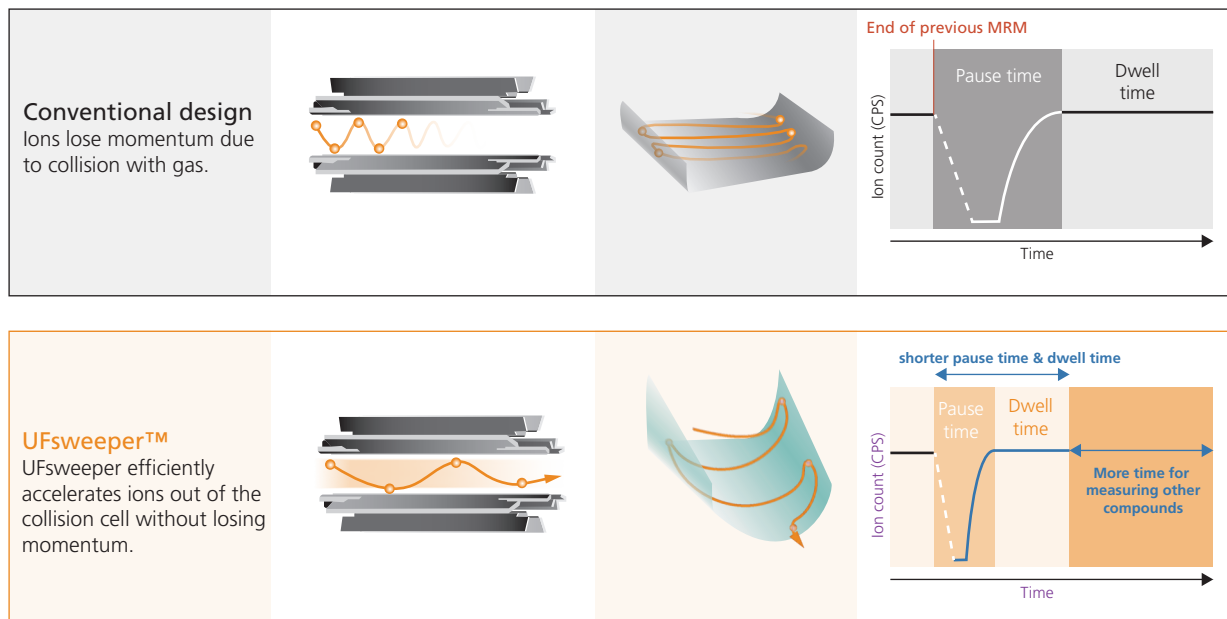
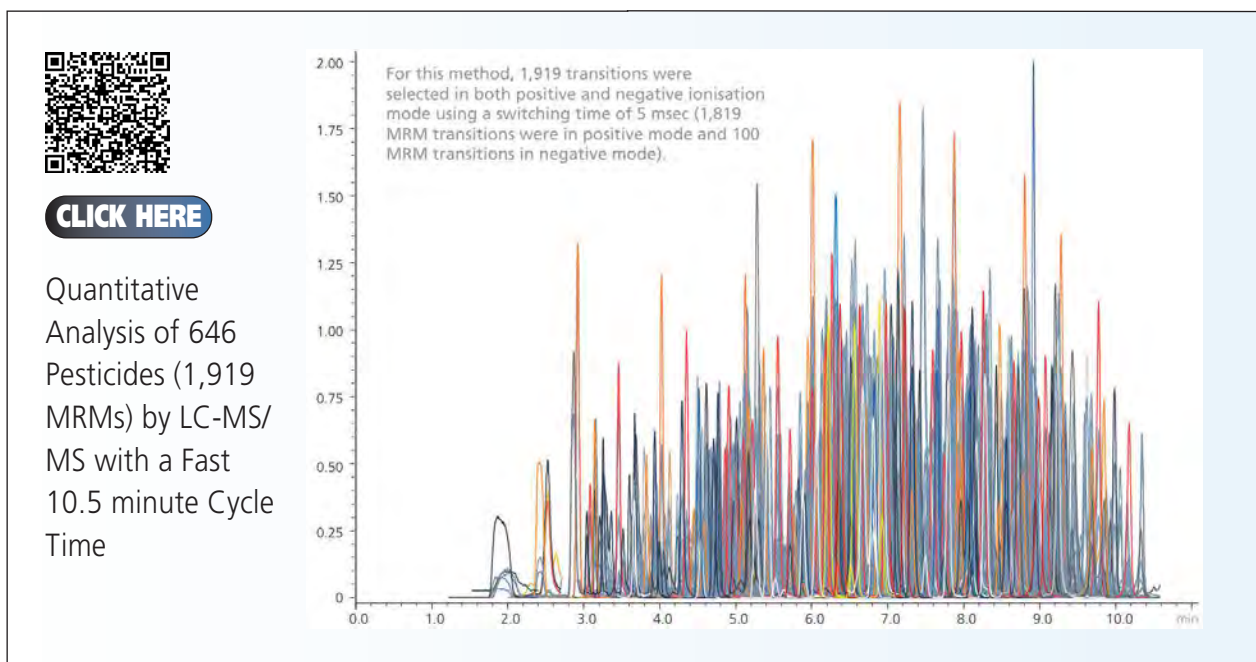

Figure 27. Comparison of a conventional collision cell and UFsweeper™ collision cell.

in data acquisition system, UF polarity switching and UF scanning is made possible. It results in shorter pause time and polarity switching time<sup>10</sup> and bring about more time for data collection. By combining all the UF technologies, the UFMS system delivers UF scanning, switching, sensitivity and MRM

to achieve the world's highest levels of sensitivity.

<sup>10</sup>Separate positive ionization and negative ionization modes may be used in LCMS. However, switching between the positive and negative ionizations during analysis is required and the time taken to switch between these modes is known as the "polarity switching time".



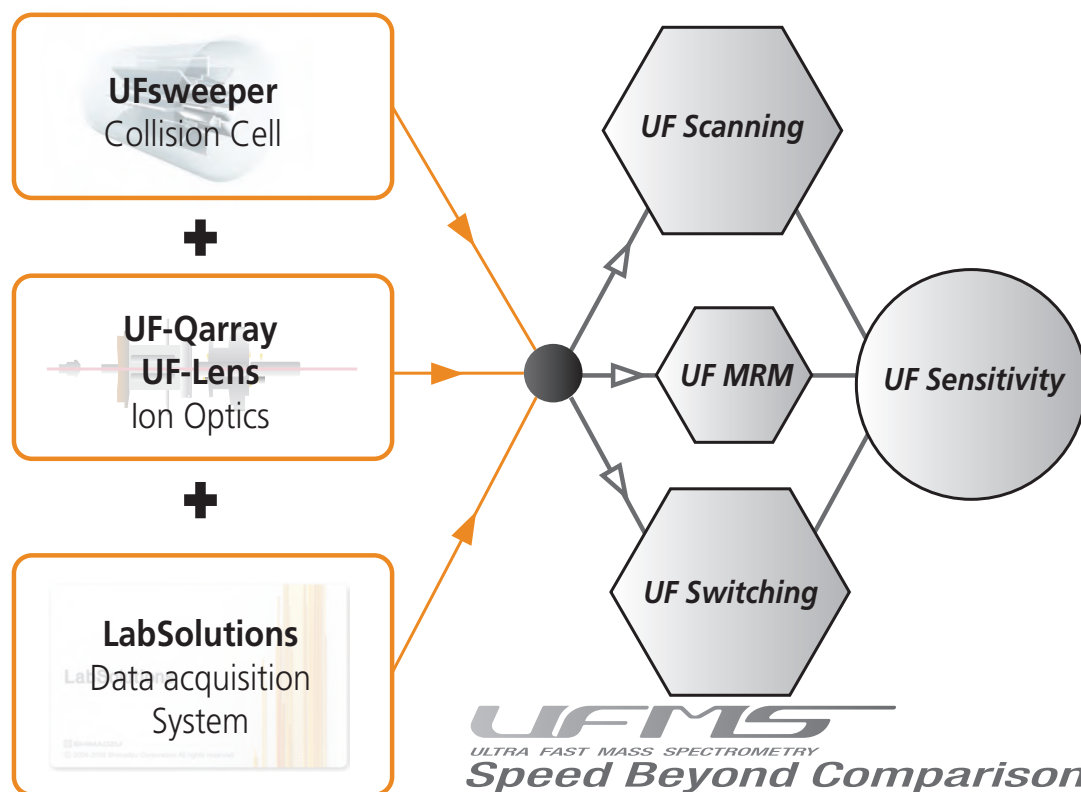

Furthermore, with the use of UFsweeper and high-speed scan analysis in UFMS, simultaneous scan and MRM analysis can be achieved where it alternates rapidly between the scan and MRM modes at high speeds. Both scan and MRM data are obtained from a single analysis. Target compounds can be quantitated from the MRM analysis results while unknown compounds can be identified by comparing the mass spectra to library search results. It maintains resolution and achieves high ion transmission even at high scanning speeds. Therefore, with the use of Shimadzu's UFMS, triple quadrupole MS can be used not only as an excellent instrument for quantitative analysis but also qualitative untargeted analysis.

### Clinical Laboratory Automation Module (CLAM)

Besides enhancing the performance and increasing the efficiency of the MS, Shimadzu has looked into innovative solutions that help to simplify the analytical workflow. Pertaining to clinical research, Shimadzu was the first to develop the CLAM, a fully automated sample preparation module for LCMS. From the initial pre-treatment to analysis, it is fully automated and individual samples are analyzed successively in parallel. Clinical scientists working with numerous samples can now utilize this instrument for increased efficiency of existing workflow and improves data reproducibility and accuracy.



**CLICK HERE**  
Learn more about features and application of CLAM

Awarded with **2016 The Analytical Scientist Innovation Award**

## Future trends of LCMS

Although there are lots of ongoing efforts and developments on LCMS, there is still more to be explored to fully unleash the capacity and potential of LCMS. Future trends and developments of LCMS are expected to still focus on achieving better performance in terms of higher throughput, quality, efficiencies and robustness.

One such development is the integration of various LC separation modes such as two-dimensional LC (2D-LC) and nano/capillary flow LC into LCMS platform. Progress is ongoing and it can improve the separating power and sensitivity of LCMS. This technology is promising for impurity analysis in pharmaceuticals and protein identification. If made easily comprehensible,

it is expected to break into widespread industrial use in the near future. There are also efforts from LCMS manufacturers in designing a more compact, lighter and greener LC system for LCMS, that requires less amount of materials, consume less volume of solvents and having less dead volumes.

Another trend aims to get more while doing less, that is to move towards minimal sample preparation without compromising on data information and quality. As discussed earlier, current sample preparation processes tend to be a laborious, time-consuming and repetitive. Therefore, the simplification of these processes and even the use of automation for LCMS is favored and



**CLICK HERE**  
Nexera Mikros  
Micro flowrate LCMS

Previously, nano-flow rate compatible LCMS systems often suffer from complications in terms of instrument operability and processing speed. With Shimadzu's Nexera Mikros, a micro-flow rate LCMS, a wide range of flow rates, from semi-micro-flow rates (100  $\mu\text{L}/\text{min}$  to 500  $\mu\text{L}/\text{min}$ ), to micro-flow rates (1  $\mu\text{L}/\text{min}$  to 10  $\mu\text{L}/\text{min}$ ) can be accommodated. This system achieves both durability and operability while enabling analysis with at least ten times the existing sensitivity.

future developments are expected to head towards this direction. Another approach to achieve greater throughput would be a development of sophisticated software to enable multiplexing. For example, by shifting from the original serial data acquisition to parallel data acquisition, allowing more samples to be analyzed in a shorter period. With the combined efforts in sample preparation, software developments and data integration, the streamlining of LCMS workflow from the initial sample preparation to the final data analysis enables LCMS to be a one-stop, highly reliable, efficient and automated process.

Given its strengths and versatility, LCMS is expected to continue to be the analytical technique of choice for both quantitative and qualitative analyses in many applications. However, to allow the market to enjoy the

multitude of benefits that LCMS can bring to their analysis, LCMS providers will need to reach out to them and knock down the markets' perceived barriers to LCMS.

In conclusion, LCMS is a powerful and versatile tool equipped with both separating and detection capabilities. This fundamental guide covers the key concepts and principles of LCMS and describe the various types of LCMS and LC-MS/MS instruments in details. We hope that the contents provide you with a comprehensive overview and assist in your LCMS analyses. Driven by our policy of contributing to society through science and technology, we strive to further improve our technologies, create unique solutions and innovative breakthroughs with a diverse product range to protect and restore the environment, and to deliver better health and lifestyles to people.

## Shimadzu's Comprehensive LC and MS Solutions

### HIGH RELIABILITY AND EXCEPTIONAL PERFORMANCE LC SYSTEMS

Shimadzu provides a wide variety of LC systems (HPLC, UHPLC, integrated, UC, 2D-LC) to meet user requirements in nearly every market and applications.



### MASS SPECTROMETRY

With our outstanding capabilities in MS, we produce various MS and tandem MS techniques specifically catered for your quantitative and qualitative analyses.

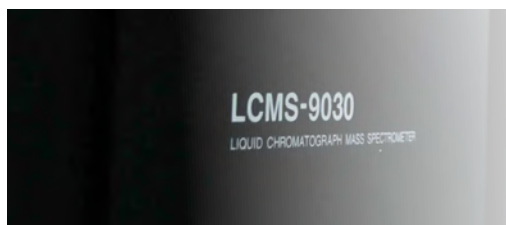



## AUTOMATION

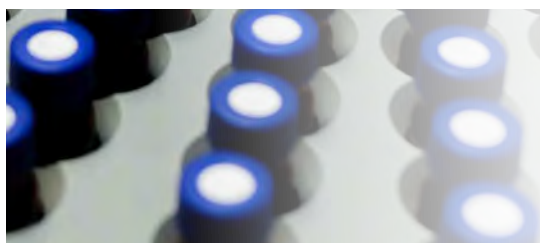

With our promise in innovation, Shimadzu constantly develops new methods and products in automation and integration to simplify your workflow and achieve high productivity and accurate results.

## DATA MANAGEMENT AND SOFTWARE

Our LabSolutions analysis data system features an innovative operating environment and provides complete data management to ensure secure information in networked laboratories.

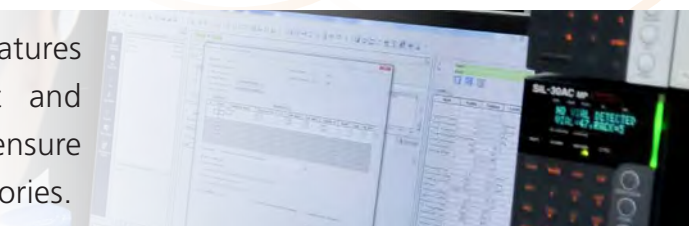

## APPLICATION SUPPORT AND DATABASE



Shimadzu is equipped with extensive libraries and databases, application notes, method development and solution system packages to support all your analyses.

## VERSATILE COUPLING WITH SPECTROSCOPY TECHNIQUES

Shimadzu provides a variety of spectroscopic techniques and detectors available for coupling with LC (e.g. fluorescence, photodiode array, UV-Vis and conductivity).



## FULL RANGE OF LABORATORY CONSUMABLES & SERVICES



We offer a wide range of laboratory consumables such as LC columns and vials, sample preparation products. Labtotal Smart Service Net provides extensive assistance which includes laboratory asset management and application support.

Find us on 



Linked 



 ResearchGate



Contact us

<https://www.shimadzu.com/an/contact/index.html>



First Edition: October, 2018



Shimadzu Corporation

[www.shimadzu.com/an](http://www.shimadzu.com/an)

**For Research Use Only. Not for use in diagnostic procedures.**

This publication may contain references to products that are not available in your country. Please contact us to check the availability of these products in your country.

The content of this publication shall not be reproduced, altered or sold for any commercial purpose without the written approval of Shimadzu. Company names, products/service names and logos used in this publication are trademarks and trade names of Shimadzu Corporation, its subsidiaries or its affiliates, whether or not they are used with trademark symbol "TM" or "®".

Third-party trademarks and trade names may be used in this publication to refer to either the entities or their products/services, whether or not they are used with trademark symbol "TM" or "®".

Shimadzu disclaims any proprietary interest in trademarks and trade names other than its own.

The information contained herein is provided to you "as is" without warranty of any kind including without limitation warranties as to its accuracy or completeness. Shimadzu does not assume any responsibility or liability for any damage, whether direct or indirect, relating to the use of this publication. This publication is based upon the information available to Shimadzu on or before the date of publication, and subject to change without notice.

© Shimadzu Corporation, 2019